

THE
NEW
CONCEPT
OF
LAUNDRY

W&D

Wash'n'dry

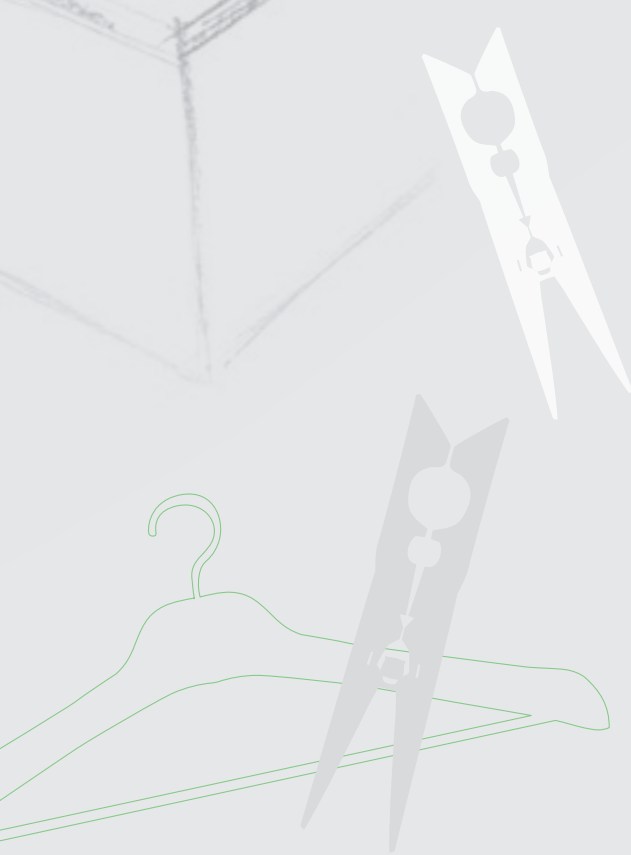
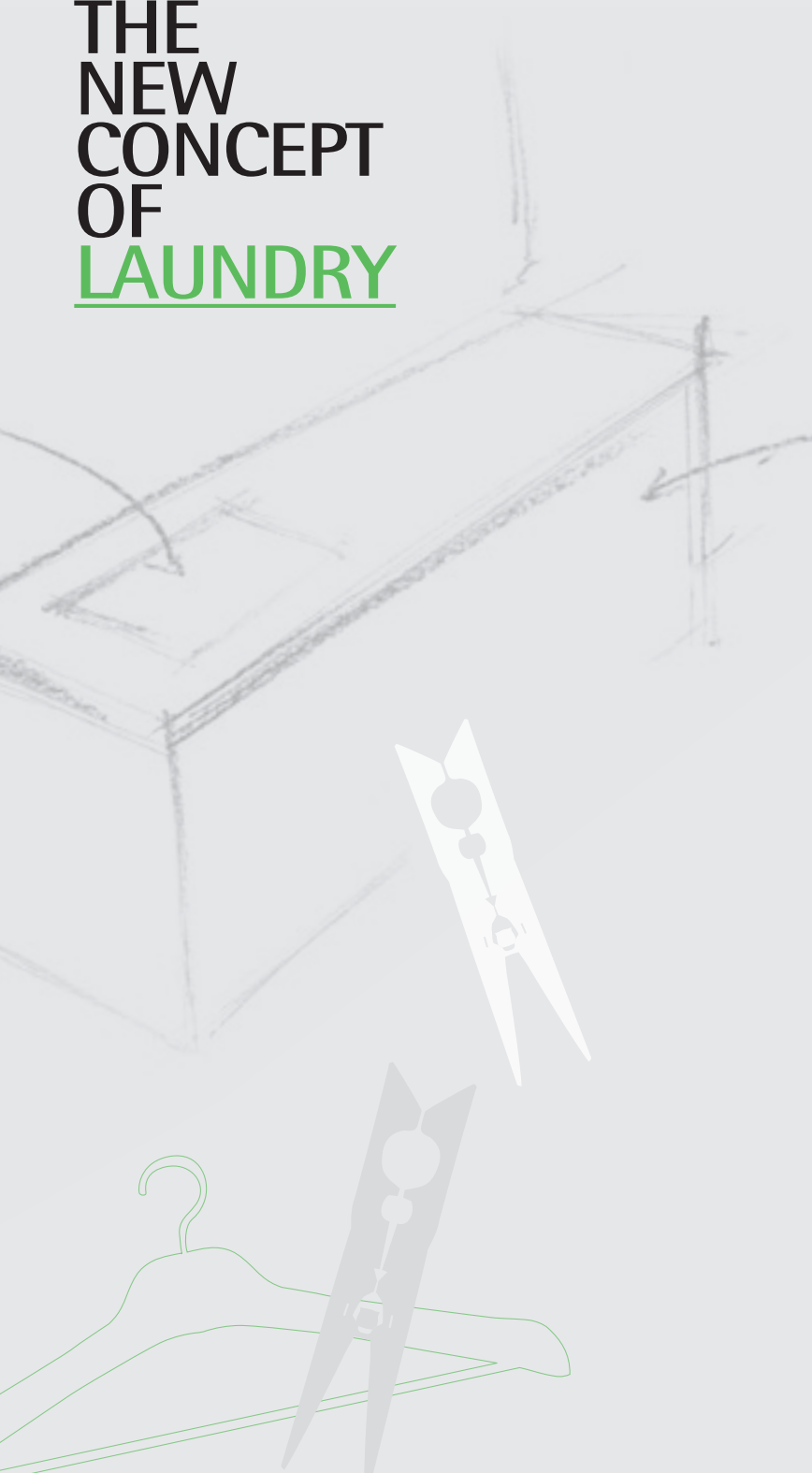

AK
BATHROOM

LA LAVANDERIA
SFOGGIA UNA
COLLEZIONE DI
ELEMENTI
FUNZIONALI
E VERSATILI,
DALL'ESTETICA
DINAMICA E
ACCATTIVANTE

THE LAUNDRY ROOM
BOASTS A COLLECTION OF
FUNCTIONAL AND VERSATILE
ELEMENTS, WITH DYNAMIC AND
CAPTIVATING AESTHETICS

W&D

Wash'n'dry

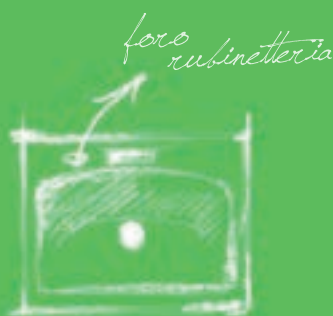

*lavabo incasso
soprapiano*

ante

*top al metro
lineare*

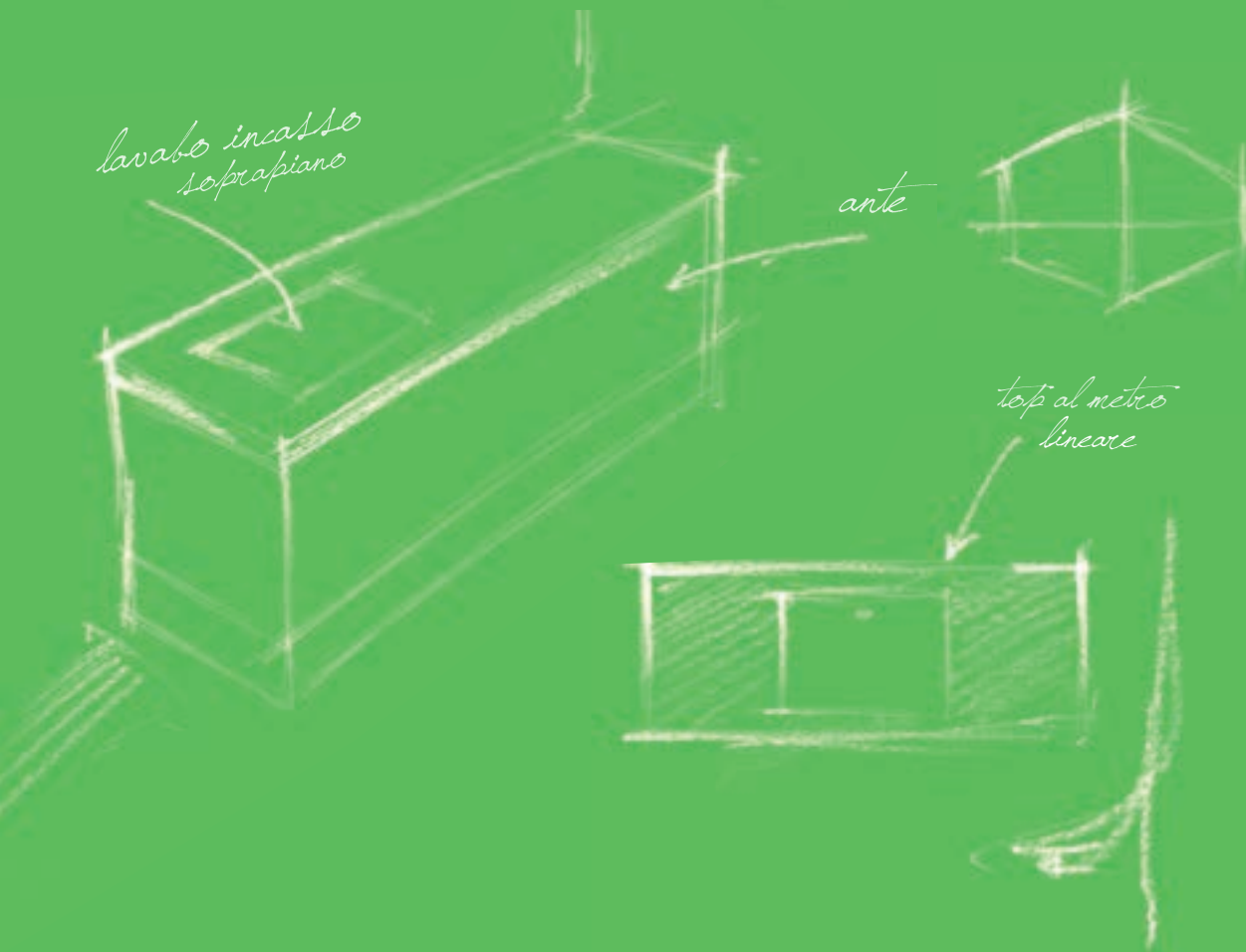



W&D
Wash'n'dry



3 tipologie di lavabo

CERAMICA
TEKNORIL
MINERALGUSS

3 wash basin types:
ceramic, teknoril, mineralguss

top sp 1,2 - 1,8 - 6 cm

Tops with sp 1,2 - 1,8 - 6 cm

Dimensioni

A MISURA

Customised sizes

elementi funzionali ED ERGONOMICI

Functional and ergonomic elements

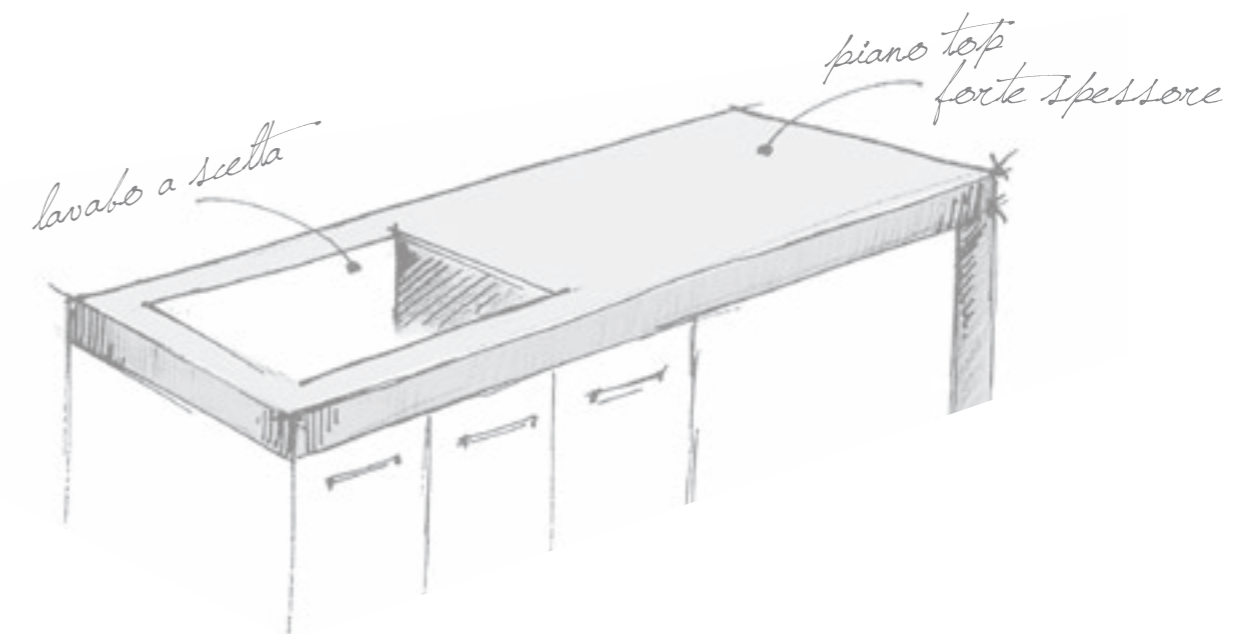



lavabo in CERAMICA / ceramic wash basin



LAVABO BALNEA

Lavabo in ceramica bianca
L 59 - P 34,5 - H 35 cm (interno vasca)



Un piano struttura in Unicolor Bianco Dax spesso 6 cm definisce la composizione. Il lavatoio in ceramica da incasso soprapiano, con incavo portasapone lavorato a rilievo e miscelatore decentrato, è illuminato dal faretto sottopensile a led.

A 6 cm thick Unicolor White Dax surface structure defines the composition. The built-in counter top ceramic wash tub, with grooved, relief soap-holder and off-centre tap, is illuminated by the LED under-unit spotlight.

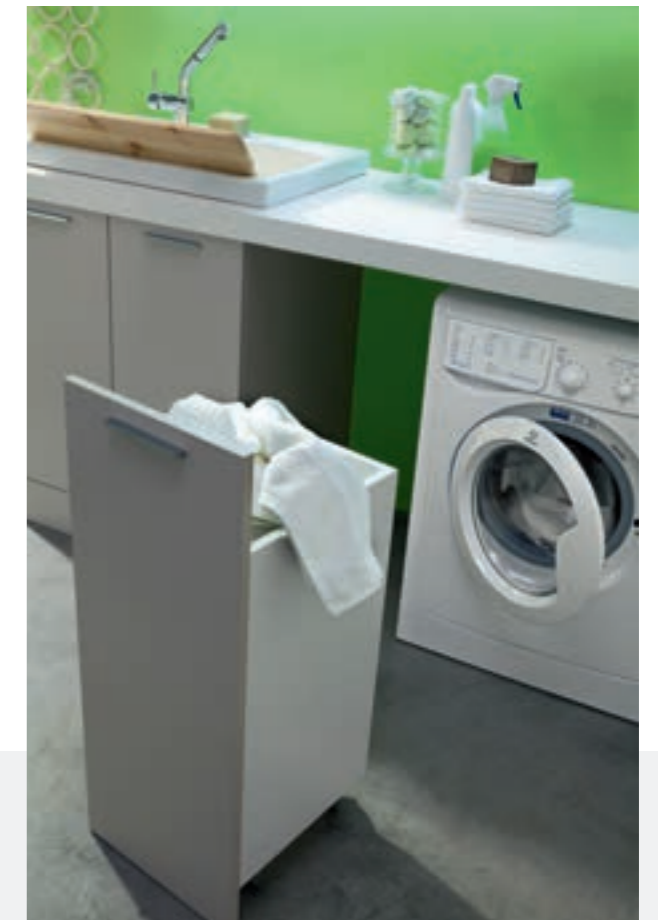

Il carrello portabiancheria, inserito tra contenitori e lavatrice, si sposta su ruote per un utilizzo più comodo e veloce.

The laundry trolley, inserted between the storage units and washing machine, can be wheeled making it more convenient and more readily available.

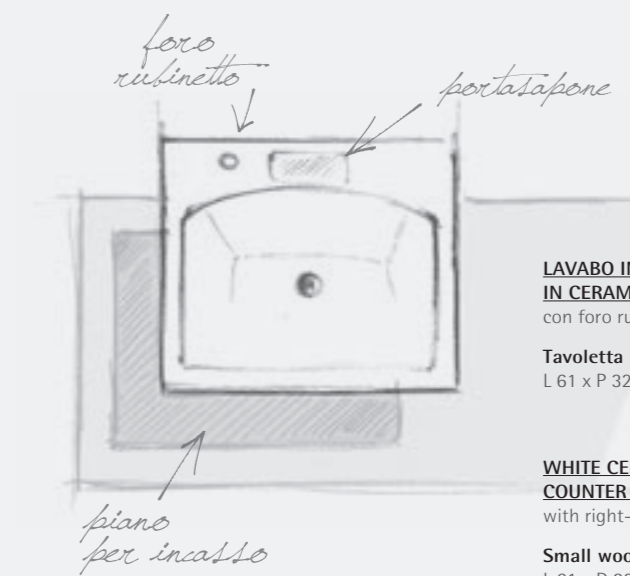

**LAVABO INCASSO SOPRAPIANO
IN CERAMICA BIANCA**
con foro rubinetto dx-sx

Tavoletta in legno (a richiesta)
L 61 x P 32 cm

**WHITE CERAMIC BUILT-IN
COUNTER TOP WASH BASIN**
with right-left tap hole

Small wooden board (upon request)
L 61 x D 32 cm



lavabo in CERAMICA / ceramic wash basin



top 6cm

3 Profondità



TOP CON FORTE SPESSORE

Disponibile con spessore da 1,2/1,8/6 cm
 Profondità 38/51/63 cm
 Lunghezza massima da 210/250 cm

Il frassino bianco è abbinato all'Unicolor Cemento del fianco e del piano, dove c'è spazio anche per il fasciatoio. La base è completa di modulo porta lavabo e porta lavatrice a due ante.

The white ash is paired with the Unicolor Cemento of the side and top, where there is also room for a changing table. The base is completed with a wash basin support module and two-door washing machine front.

TOP 1,2 cm
 solo in teknoril e teknorit

TOP 1,2 cm
 only in teknoril and teknorit

TOP 1,8 cm
 tutte le finiture disponibili (larice, rovere, frassino...)

TOP 1,8 cm
 all finishes available (larch, oak, ash...)

TOP 6 cm
 solo in UNICOLOR nei colori: Bianco Dax, Cemento, Grigio venato, Porfido, Cesar Brown

TOP 6 cm
 only in UNICOLOR in the following colours: White Dax, Cemento, Grigio venato, Porfido, Cesar Brown





CARRELLO ESTRAIBILE ACCESSORIATO

L 50 - P 50 - H 87 cm



Una soluzione salva spazio ricca di funzionalità. Il carrello su ruote è un'idea dinamica che unisce un cesto portabiancheria a ribalta, un vano superiore portaoggetti e gli accessori posteriori per i detersivi e i saponi. Da usare come si vuole, dove si vuole.

A space-saving solution, bursting with functions. The wheeled trolley represents a dynamic idea which fuses a flap laundry basket, a top compartment for storing objects and further accessories for detergents and soaps. To be used liberally, whenever you wish.



Il carrello è perfettamente inserito nella base, con la stessa anta e maniglia.

The trolley fits perfectly into the base which displays a matching door and handle.



Si estrae per accedere al vano porta oggetti superiore.

It is extracted in order to access the top object storage compartment.



L'anta a ribalta consente in ogni momento l'uso del portabiancheria.

The flap door enables the use of the laundry basket at any given time.



Libero e indipendente, si sposta all'occorrenza dove più serve.

Unrestricted and independent, it can be moved to wherever it is needed.



lavabo in CERAMICA / ceramic wash basin

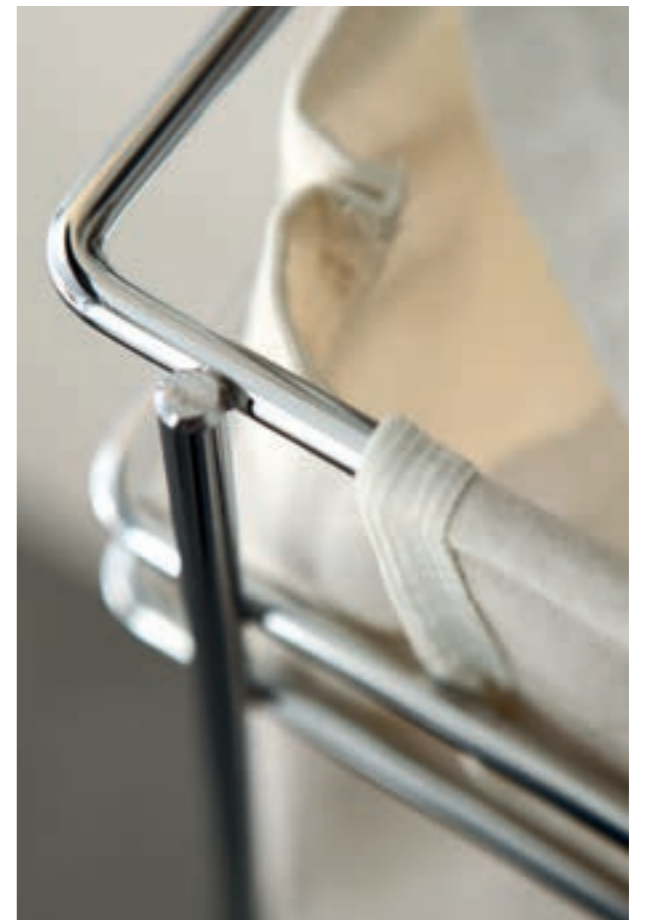

ELEGANZA FUNZIONALE

Comoda praticità nella zona lavanderia



Una base con la finitura in larice bicolore ecrù e una struttura verticale a spalla in Unicolor Cesar Brown spessore 6 cm: la lavanderia moderna scopre il vantaggio di una progettualità libera, con il cesto portabiancheria estraibile e il lavabo in ceramica.

A two colour ecrù brushed larch finish base and a 6 cm thick vertical structure with Unicolor Cesar Brown back support: the modern laundry room boasts design freedom, with the extractable laundry basket and ceramic wash basin.





lavabo in CERAMICA / ceramic wash basin



SOLUZIONE AD ANGOLO



Il volume interno dell'angolo è accessibile grazie ad un ripiano in Unicolor Cesar Brown da 6 cm dove poter riporre accessori e detersivi.

The entire corner space is accessible thanks to a 6 cm, Unicolor Cesar Brown shelf on which it is possible to place accessories and detergents.



Due piani profondi 63 cm si incontrano a formare un vano a giorno racchiuso tra la base portalavabo e le colonne attrezzate. Una composizione studiata per il massimo sfruttamento dell'angolo.

Two 63 cm deep tops come together to form an open unit between the wash basin base and the equipped tall units. A composition designed to make the most out of the corner space.

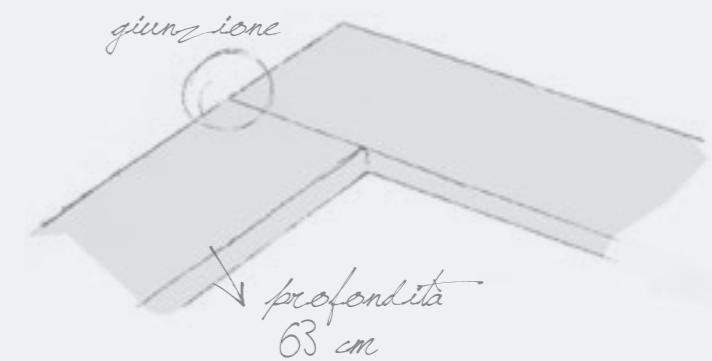



COLONNE ATTREZZATE

per ogni esigenza di spazio

Vani attrezzati con asse da stiro, cestelli e barra appendiabiti estraibili si affiancano a vani con divisori e ripiani interni per tenere le scope e l'aspirapolvere separati da accessori e flaconi.

Units equipped with ironing boards, baskets and extractable clothes hangers are united with units with dividers and internal shelves which separate brooms and vacuum cleaners from accessories and bottles.





CESTONE CON CHIUSURA DI SICUREZZA

Con chiave in dotazione



Detersivi, disinfettanti, smacchianti: in lavanderia ci sono sempre prodotti pericolosi che è meglio tenere sotto chiave. Per questo uno dei contenitori della base è provvisto di serratura, in modo che i bambini non corrano alcun rischio.

Detergents, disinfectants, stain removers: there are always dangerous products in the laundry room; it is best to keep them locked away. For this very purpose, one of the storage units is equipped with a lock, so that there is no risk to children.



Elemento estraibile con contenitori e cestino completo di coperchio.

Extractable element with storage units and basket complete with cover.

Contenitore estraibile dal telaio di protezione con chiusura a chiave.

Extractable storage unit with protective frame and lock.



TOP IN TEKNORIL sp 1,2 cm
LUCIDO E OPACO
 con vasca integrata Conca

GLOSS AND MATT TEKNORIL
TOP - 1.2 cm thick
 with built-in Conca wash basin

Lunghezza massima 210 cm
 Il lavabo viene posizionato a scelta

Maximum length 210 cm
 The hole can be placed where desired

Doppia profondità
 51 / 63 cm

Double depth
 51 / 63 cm

Misure interno vasca
 L 53 / P 38 / H 20 cm

Internal basin dimensions
 W 53 / D 38 / H 20 cm

LAVABO IN TEKNORIL A MISURA

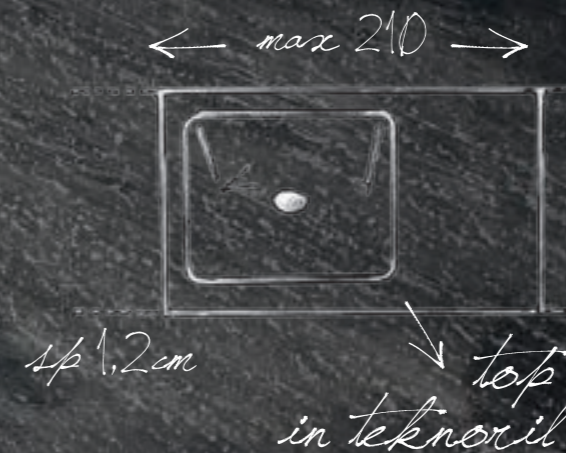

L'ANIMA TRADIZIONALE
 E QUELLA TECNOLOGICA
 DELLA LAVANDERIA
 SI INCONTRANO IN
 UNA COMPOSIZIONE
 ERGONOMICA E
 ORIGINALE IN BIANCO
 LUCIDO CON MANIGLIA
 CROMO E MENSOLE IN
 UNICOLOR PORFIDO.

THE TRADITIONAL AND TECHNOLOGICAL
 SPIRIT OF THE LAUNDRY ROOM
 FUSE WITHIN AN ERGONOMIC AND
 ORIGINAL COMPOSITION IN GLOSS
 WHITE WITH CHROME HANDLES AND
 UNICOLOR PORFIDO SHELVES.



lavabo in TEKNORIL / Teknoril wash basin



LE COLONNE RIALZATE

La comodità e la praticità in un'unica soluzione



Lavatrice e asciugatrice si trovano all'altezza ideale nelle due colonne in appoggio sulla struttura in Unicolor Porfido. Sotto si inseriscono i due carrelli portabiancheria in metallo bianco. E per i capi da lavare a mano, c'è il lavabo integrato in teknoril completo di tavoletta lavabiancheria e alzatina sagomata di protezione.

The washing machine and tumble-dryer can be found at the perfect height within the two supporting units of the Unicolor Porfido structure. The two white metal laundry trolleys can be placed underneath. When it comes to items which require hand washing, there is the built-in teknoril wash basin complete with laundry board and shaped protective splash-guard.

base portabiancheria

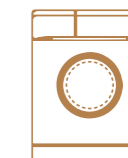
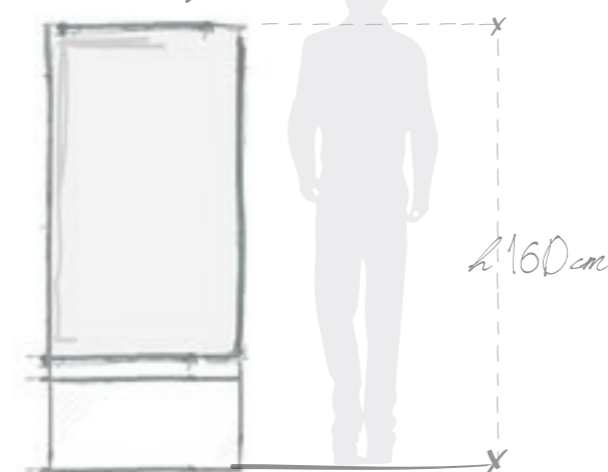



lavabo in TEKNORIL / Teknoril wash basin



DOPPIA PROFONDITÀ

P 51 con rubinetteria a muro
P 63 con rubinetteria a muro o sul top

→
La base sospesa con top e lavabo integrato, è completa di tavoletta lavabiancheria in teknoril a due posizioni. Il tutto è racchiuso da fianchi di finitura e top inferiore laccato bianco opaco.

The wall base unit with top and built-in wash basin is completed with the two-position teknoril laundry board. Everything is encapsulated within finishing sides and matt white lacquered base top.

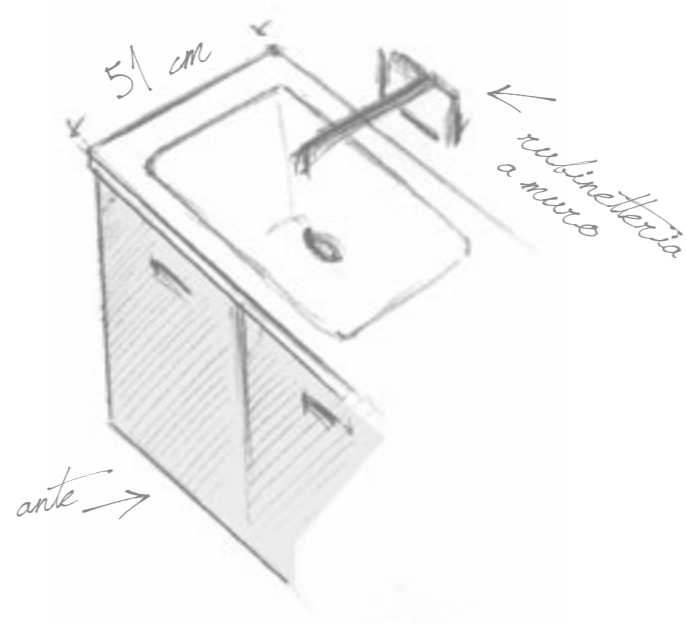

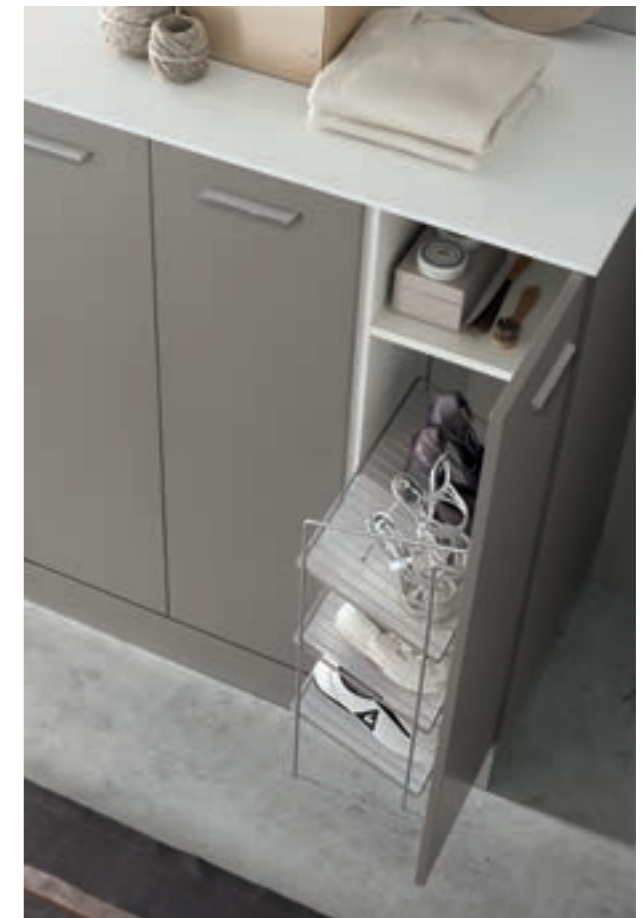

VERSATILE E RAZIONALE

Progetti per creare e arredare stili diversi



Nella colonna portalavatrice a due ante alta 125 cm un ripiano superiore crea due vani per gestire più comodamente le operazioni. Dall'altro lato, una colonna con portascarpe estraibile in tondino metallico aggiunge un'ulteriore e utile funzionalità.

Within the two-door washing machine unit, 125 cm in height, a top shelf serves to establish two compartments to enable convenient management of activities. On the other side, a tall unit with extractable shoe holder in metal reinforcing rod provides yet another useful function.





lavabo in TEKNORIL / Teknoril wash basin





COLONNA PRATICA E FUNZIONALE

Soluzioni attrezzate, per riporre tutti gli oggetti



La colonna alta 200 cm è progettata per contenere l'aspirapolvere. Il fianco è attrezzato con appendini portascopie e l'anta con l'accessorio avvolgitubo e porta detersivi. Un'idea multifunzionale e salvaspazio inserita nella composizione.

The 200 cm tall unit is designed to store the vacuum cleaner. The side is equipped with hanging door organisers and the door with hose reel and detergent holder. A multifunctional and space-saving idea, all part of the composition.





PIANO CON VASCA
INTEGRATA E
TAVOLETTA IN
TEKNORIL DA USARE
COME CHIUSURA A
MEZZA PROFONDITÀ
O COME APPOGGIO
PER IL LAVAGGIO.
UNA LAVANDERIA,
TANTE IDEE.

TOP WITH BUILT-IN WASH BASIN
AND BOARD IN TEKNORIL TO BE
USED AS A CLOSURE AT HALF
DEPTH OR AS A SUPPORT WHEN
WASHING. ONE LAUNDRY ROOM,
COUNTLESS IDEAS.



lavabo in MINERALGUSS / Mineralguss wash basin

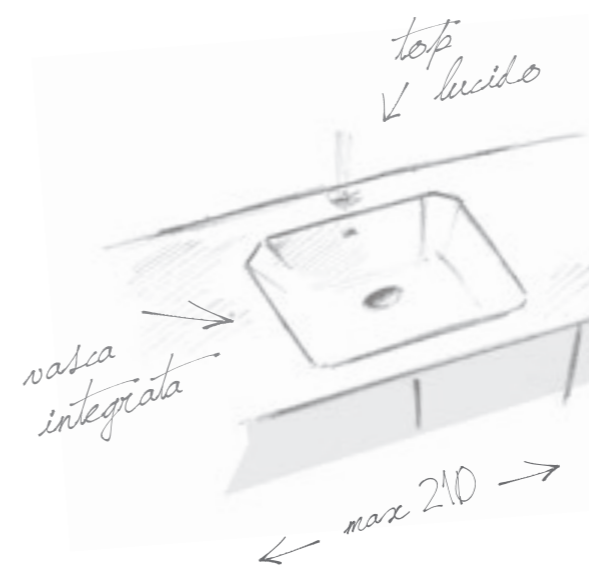

LAVABO IN MINERALGUSS

Con vasca integrata
(misure interne L 51 / P 33 / H 21 cm)

→
La composizione segue criteri di praticità valorizzando l'armonia di ogni soluzione, dalle colonne porta lavatrice e asciugatrice ai vani a giorno, dai contenitori al piano lavabo con vasca molto capiente e un'ottima superficie d'appoggio.

The composition takes into consideration practicalities whilst heightening the balance of each solution, from the washing machine and tumble-dryer tall units to the various open units, from the storage units to the wash basin top, with extremely capacious basin and excellent support surface.

TOP 1,2 cm
versione lucido

TOP 1,2 cm
gloss version

Lunghezza massima 210 cm
Il foro viene posizionato a scelta

Maximum length 210 cm
The hole can be placed where desired

Doppia profondità
51 / 63 cm

Double depth
51 / 63 cm



LAVABO SEMINCASSO IN MINERALGUSS

P 38 con rubinetteria a muro
P 51 con rubinetteria a muro o sul top
P 63 con rubinetteria a muro o sul top



Il lavabo integrato nel piano sporge leggermente per avere una vasca di comoda ampiezza senza dover aumentare la profondità della base sospesa. La gestione dello spazio stabilisce nuove relazioni tra ingombri e praticità.

The wash basin built into the top overhangs slightly providing a large basin without having to increase the depth of the wall hung base unit. Space management takes on new meaning with the associations between measurements and practicalness.

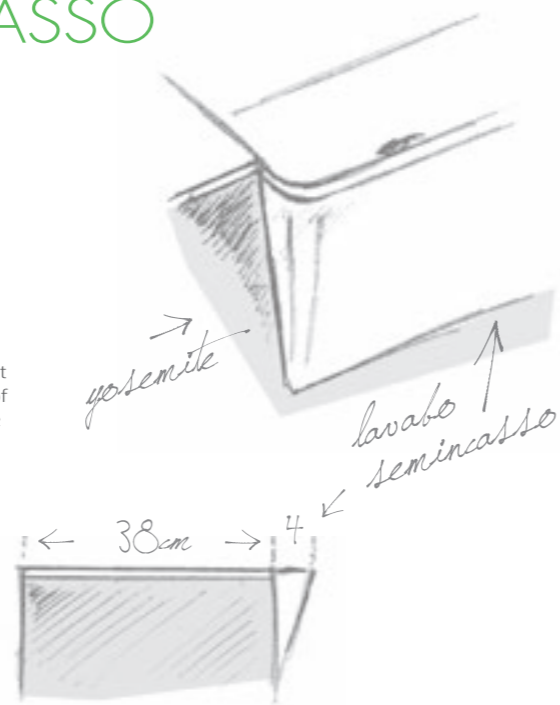

lavabo in MINERALGUSS / Mineralguss wash basin

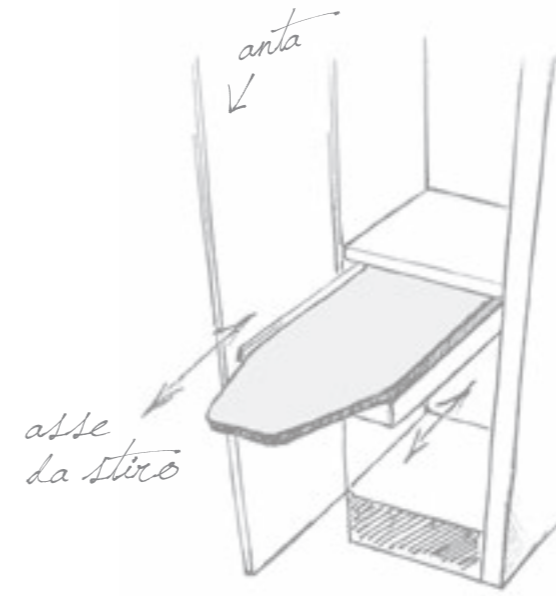
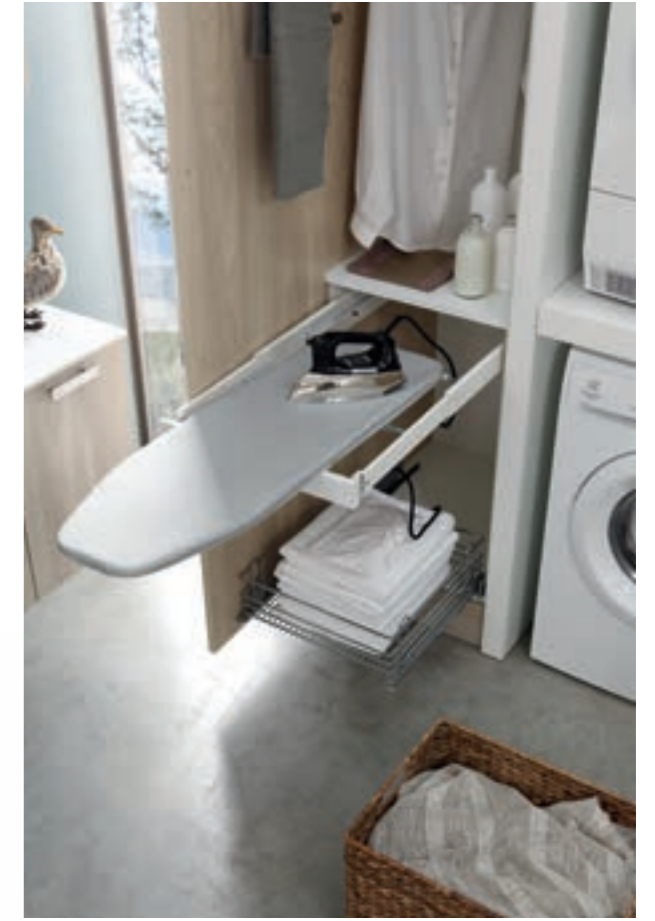

L'ASSE DA STIRO ESTRAIBILE

Praticità in lavanderia



Lavare, asciugare e stirare: un'unica struttura con colonne attrezzate e vani tecnici riunisce le principali funzioni della lavanderia. E' una soluzione ideale per trasformare un locale di dimensioni contenute in un ambiente comodo e funzionale.

Washing, drying and ironing: a single structure with equipped tall units and technical compartments brings together the main functions of the laundry room. The ideal solution to transform an area with limited space into a convenient and functional room.

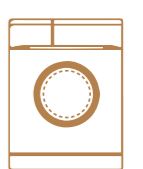
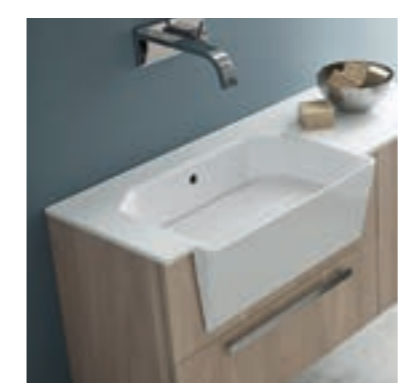



W&D
Wash'n'dry



THE NEW CONCEPT OF LAUNDRY

IL NUOVO CONCETTO
DELLA LAVANDERIA

composizioni
Compositions

modularità
Modularity

finiture
Finishes

maniglie
Handles

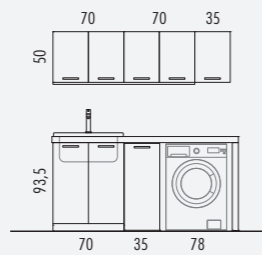

**W&D 01****L 183 P 63 cm**

Agata opaco con maniglia 163 cromo
Lavabo incasso in ceramica Balnea
Top unicolor Bianco Dax sp.6 cm

Matt Agata with 163 chrome handle
Built-in ceramic Balnea wash basin
6 cm thick Unicolor White Dax top

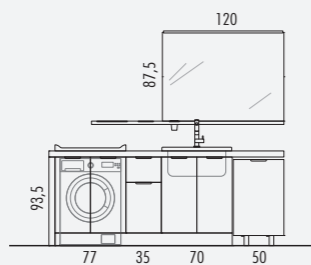
**W&D 02****L 232 P 63 cm**

Frassino bianco con maniglia 243 brill
Lavabo incasso in ceramica Balnea
Top unicolor Cemento sp.6 cm

White ash with 243 brill handle
Built-in ceramic Balnea wash basin
6 cm thick Unicolor Cemento top

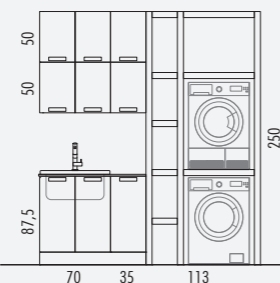
**W&D 03****L 219 P 51 cm**

Larice bicolore ecrù con maniglia 253 cromo
Lavabo incasso in ceramica Balnea
Top unicolor Cesar Brown sp.6 cm

Two-tone ecru larch with 253 chrome handle
Built-in ceramic Balnea wash basin
6 cm thick Unicolor Cesar Brown top

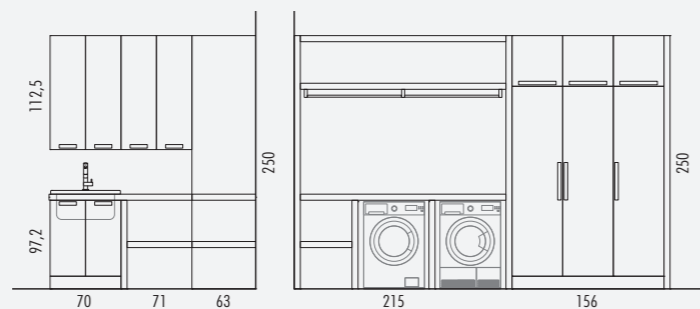
**W&D 04****L 204/371 P 63 cm**

Bianco opaco con maniglia 253 cromo
Lavabo incasso in ceramica Balnea
Top unicolor Grigio Venato sp.6 cm

Matt white with 253 chrome handle
Built-in ceramic Balnea wash basin
6 cm thick Unicolor Grigio venato top

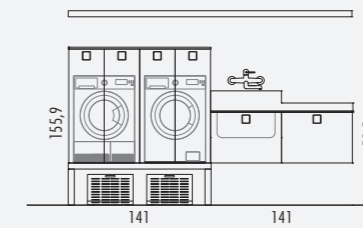
**W&D 05****L 281 P 51/63 cm**

Bianco lucido con maniglia 263 cromo
Particolari Unicolor Porfido
Top in teknoril con lavatoio integrato Conca

Gloss white with 263 chrome handle
Unicolor Porfido details
Top in teknoril with built-in Conca washtub

**W&D 06****L 107,5 P 63 + 2 colonne L 70 P 63 cm**

Magma opaco con maniglia 163 cromo
Top in teknoril sp.1,2 cm
con lavatoio integrato Conca

Matt Magma with 163 chrome handle
1.2 cm thick teknoril top
with built-in Conca washtub

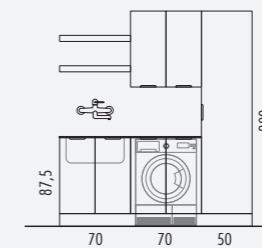
**W&D 07****L 191 P 51 cm**

Rovere tranchè canapa con particolari
rovere tranchè marrone
Maniglia 243 brill
Top in teknoril sp.1,2 cm
con lavatoio integrato Conca

Canapa tranchè oak with Marrone tranchè oak
details 243 brill handle
1.2 cm thick teknoril top
with built-in Conca washtub

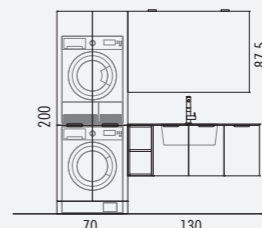
**W&D 08****L 201 P 51/63 cm**

Bianco lucido con maniglia 243 brill
Top in mineralguss sp.1,2 cm
con lavatoio integrato Fonte

Gloss white with 243 brill handle
1.2 cm thick mineralguss top
with built-in Fonte washtub

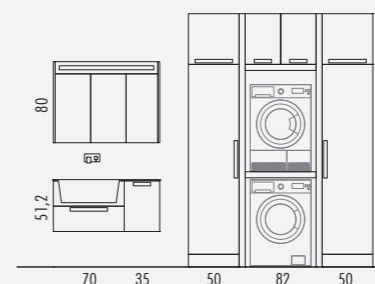
**W&D 09****L 106 P 38/42 + colonne L 182 P 51 cm**

Yosemite chiaro con particolari Unicolor bianco dax
Maniglia 253 cromo
Top in mineralguss sp.1,2 cm
con lavatoio semincasso integrato Fonte

Light Yosemite with Unicolor White Dax details
253 chrome handle
1.2 cm thick mineralguss top
with built-in semi-recessed Fonte washtub

Pensili p. 20,8 / 37 cm

Wall units

H 50	H 75	H 112,5	H 50	H 75	H 112,5	H 50	H 50
L 25 35	L 25 35	L 25 35	L 50 L 70	L 50 L 70	L 50 L 70	L 50 L 70	L 70
1 anta 1 door	1 anta 1 door	1 anta 1 door	2 ante 2 doors	2 ante 2 doors	2 ante 2 doors	1 anta 1 door	a ribalta flap a ribalta con fondo stendibiancheria flap with bottom drying rack

Basi a terra p. 37 / 50 / 62 cm

Floor-standing base units

H 87,5						
L 25 35	L 25 35	L 25 35 L 50 L 70	L 35 L 50	L 50 L 70	L 50 L 70	
						*a ribalta con cesto porta biancheria *flap with bottom drying rack
1 anta 1 door	1 anta+1 cassetto 1 door+1 drawer	3 cassetti 3 drawers	1 anta 1 door	2 ante 2 doors	2 ante+1 cassetto 2 doors+1 drawer	
solo P 50/62* only D 50/62*						

Basi sospese p. 37 / 50 / 62 cm

Wall-mounted base units

H 50						
L 25 35 L 50	L 25 35 L 50 L 70	L 25 35 L 50 L 70	L 25 35 L 50 L 70	L 25 35 L 50 L 70	L 25 35 L 50 L 70	
1 anta 1 door	2 cassetti 2 drawers	1 cassetto 1 drawer	a giorno open units	2 ante 2 doors		
solo P 37/50 only D 37/50						

Colonne p. 37 / 50 / 62 cm

Tall units

H 125	H 200	H 50		H 50	
L 25 35	L 25 35	L 25 35	L 25 35	L 50 L 70	L 50 L 70
1 anta 1 door	2 ante 2 doors	2 ante+1 cassetto 2 doors+1 drawer	2 ante 2 doors	4 ante 4 doors	4 ante+1 cassetto 4 doors+1 drawer
solo P 50/62* only D 50/62*					

*a ribalta con cesto
porta biancheria
*flap with bottom
drying rack

Colonne e basi portalavatrice p. 50 / 62 cm

Tall units and washing machine bases

H 87,5	H 125	H 200
L 70	L 70	L 70
2 ante 2 doors	2 ante 2 doors	4 ante 4 doors

Basi portalavabo sospese p. 37 / 50 / 62 cm

Washing machine wall-mounted base units

H 50						
L 70	L 70 L 85 L 95 L 105	L 85 L 95 L 105	L 70 L 85 L 95 L 105	L 70 L 85 L 95 L 105	L 85 L 95 L 105	L 85 L 95 L 105
2 ante 2 doors	1 cassetto 1 drawer	3 ante 3 doors	1 fisso+ 1 cassetto 1 fixed 1 drawer	2 cassettoni 2 drawers	2 ante+ 2 cassettoni 2 doors+ 2 drawers	1 cassetto+ 2 cassetti 1 drawer+ 2 drawers

Basi portalavabo a terra p. 37 / 50 / 62 cm

Washing machine floor-standing base units

H 87,5 / P 37			H 87,5 / P 50-62
L 70	L 85 L 95 L 105	L 95	L 70

Accessori

Accessories

H 87,5 / L 35 / P 37	H 87,5 / L 50 / P 50
Carrello con ruote Wheeled trolley	Carrello attrezzato con ruote Trolley equipped with wheels





YOSEMITE

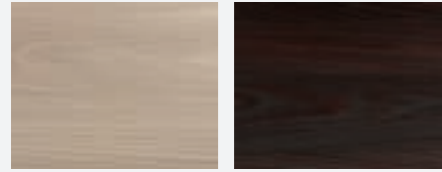

Chiaro Scuro

ROVERE TRANCÈ



Ecrù Canapa Marrone

CONDOTTI

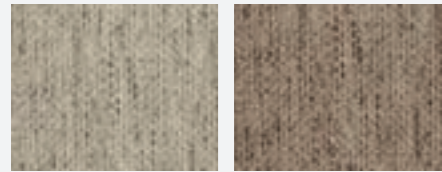

Safari Argilla

LARICE

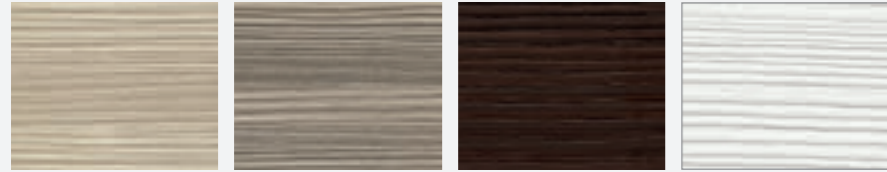

Ecrù Canapa Marrone Bianco

FRASSINO

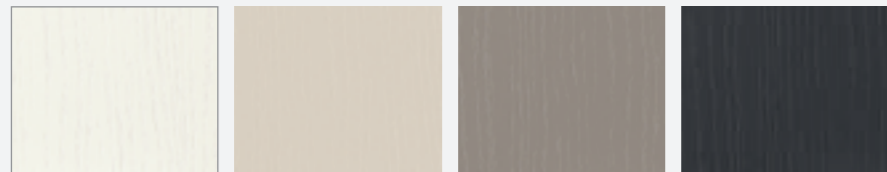

Bianco Champagne Zenzero Ardesia

SHERWOOD

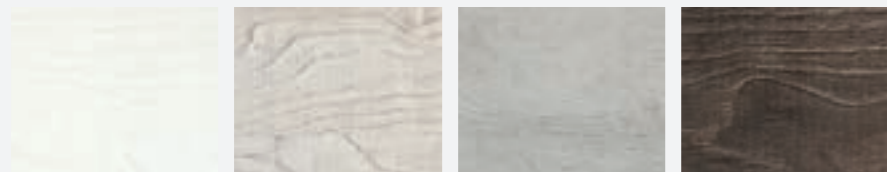

Luna Platino Polvere Burn

LARICE E FRASSINO NEI 38 COLORI

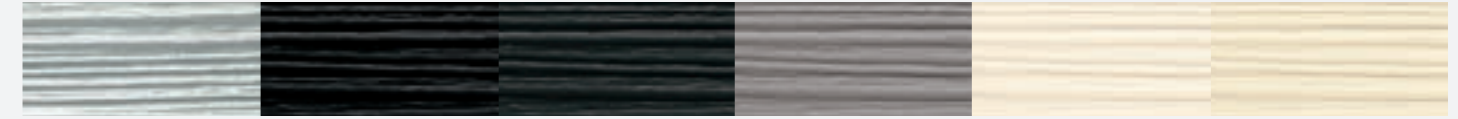

Inox Nero/Black Grigio fumo di Londra Cenere New Pergamon Ecrù



Juta Canapa Terranova Brown Cacao Terra



Visone Verde Bosco Verde Oliva Giallo Polline Giallo Solare Mattone



Rosso fuoco Bordeaux Rosso India Blu Night Blu Marin Blu Nazionale



Cascata Cielo Nuvola Navy Lavanda Glicine



Lilla Light Rosa Rosa Confetto Amarena Lampone Arancio



Verde Twigg Acquamarina

COLORE



Bianco lucido e opaco Sabbia lucido Rosso Marocco lucido Agata lucido e opaco Magma lucido e opaco Grigio antracite lucido e opaco



Maniglie disponibili

Handles available



Art. 243 brill - brill



Art. 253 cromo - chrome



Art. 163 cromo - chrome
Art. 165 alluminio - aluminium



Art. 323 cromo - chrome



Art. 263 cromo - chrome



Art. 283 cromo - chrome



Art. 273 cromo - chrome
Art. 271 bianco - white



By ARCOM srl

33070 Maron di Brugnera (PN) Italy
Viale Lino Zanussi, 34/B
T. +39.0434.613619 / 1573020
F. +39.0434.608137
info@arcombagno.com