

ARIA

LIGHT KITCHEN

Un percorso stilistico che si evolve per superare
il comune concetto che identifica la cucina.
Un progetto che ridefinisce gli standard e raggiunge
nuovi apici progettuali.

ARIA reinterpreta la percezione dello spazio
attraverso nuovi elementi compositivi all'insegna della
versatilità, rispondendo alle esigenze del vivere attuale e
creando inedite situazioni conviviali.

É l'espressione del mood più contemporaneo
che vede nuovi particolari come le basi rialzate
su telaio in metallo definiti da dettagli
dalle linee sempre più essenziali come l'anta dal bordino
minimal, la boisere con i ripiani ultrasottili
e i fianchi di chiusura di solo 12 mm di spessore.

*A stylistic path that evolves to overcome
the common concept that identifies the kitchen.
A project that redefines the standards and reaches
new design heights.*

*ARIA reinterprets the perception of space
through new component elements in the sign of versatility,
meeting the needs of current living and creating
unprecedented convivial situations.*

*It is the expression of the most contemporary mood that
sees new details such as the bases raised
on a metal frame and the open drawers defined by details
with increasingly essential lines
like the door with a minimal edge, the wood panelling with
ultra-thin shelves and closing sides only 12 mm thick.*

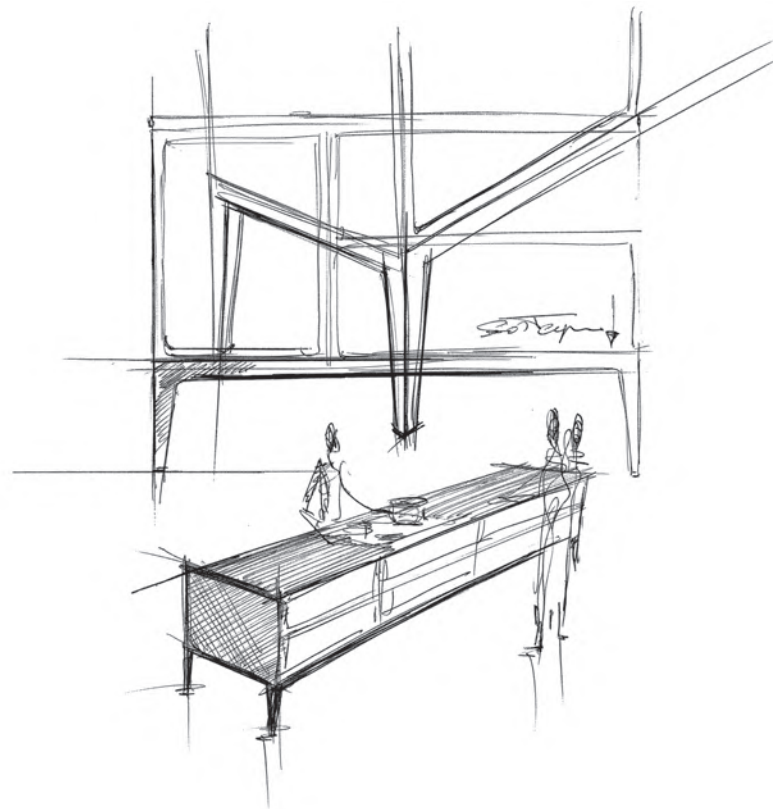
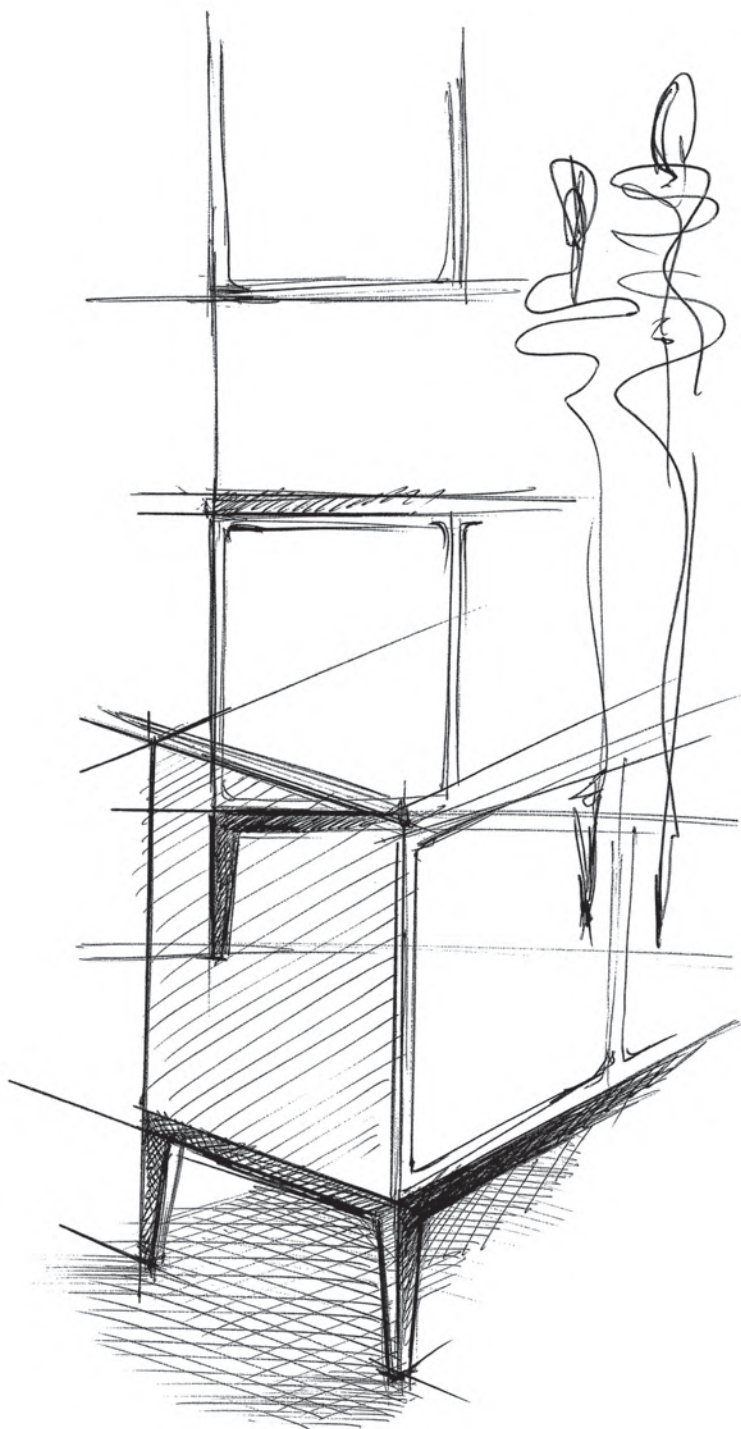

ARIA

INDICE
INDEX

ARIA

1

04.13



2

14.23



3

24.33



4

34.43



5

44.53





ARIA 1

LAMINATO PET MATT LAVAGNA
PET MATT LAVAGNA LAMINATE
 LAMINATO LARICE VAS
VAS LARCH LAMINATE
 LACCATO NEBBIA OPACO
MATT LAQUERED NEBBIA
 BRUNITO
BURNISHED
 CORIAN BIANCO OPACO
MATT WHITE CORIAN



Una composizione strutturata per coinvolgere e stupire. ARIA 1 definisce lo spazio a tutto tondo grazie alla maxi isola centrale rialzata con piano cottura e lavello. Su base rialzata anche i due moduli completi dei nuovi cestoni a giorno dal frontale sagomato. L'ampio sistema colonne a parete, con doppio forno, offre la massima libertà operativa nonché un notevole impatto scenico.

A structured composition to engage and amaze. ARIA 1 defines the space all-round thanks to the maxi raised central island with hob and sink. Also the two modules of the new open drawers, with a shaped front, are on a raised base. The wide wall eye-level system, with double oven, offers maximum freedom of operation as well as considerable scenic impact.

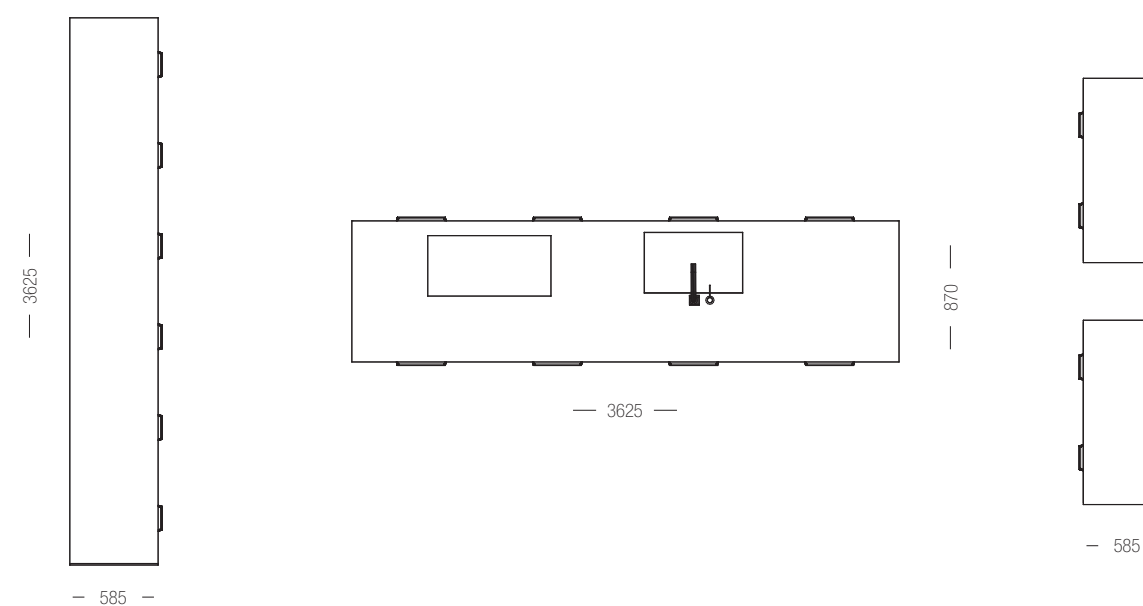





Continuità materica, estetica e funzionale definiscono il piano d'appoggio dell'isola centrale con top in corian bianco opaco. Il lavello è il risultato di un gioco di sottrazione di volumi che riprende uno dei tratti caratteristici di ARIA: la ricerca della pulizia formale come espressione di un'estetica evoluta.

Material, aesthetic, and functional continuity define the surface of the kitchen island with a matt white Corian top. The sink is the result of a volume subtraction game that resembles one of the characteristic features of ARIA: the search for formal cleansing as an expression of an evolved aesthetic.





Protagonisti di ARIA 1 sono i nuovi cestoni a giorno laccati nei colori TIME che rappresentano una novità per tutte le collezioni di cucine moderne Arredo 3. Interrompendo il ritmo regolare dell'anta piena si inseriscono all'interno della composizione come tratti estetici caratterizzanti grazie al particolare disegno del frontale che funge anche da presa.

ARIA 1 main features are the new open lacquered drawers available in the TIME colours, which are something new for all Arredo 3 modern kitchen collections. By interrupting the regular rhythm of the solid hinged door, they become part of the composition as aesthetic features thanks to the particular design of the front, which also acts as a power point.





ARIA 2

LAMINATO PET MATT LAVAGNA
 PET MATT LAVAGNA LAMINATE
 LAMINATO LARICE CORTINA
 CORTINA LARICH LAMINATE
 BRUNITO
 BURNISHED
 DEKTON KELYA
 DEKTON KELYA

Un po' cucina, un po' living questa è una composizione sui generis. Aperta e polifunzionale incarna perfettamente lo spirito dell'intero progetto ARIA.

L'importante parete attrezzata con la boiserie dai ripiani in vetro si sviluppa dal gruppo colonne, dal design netto, privo di maniglie, grazie al sistema di apertura a gola verticale.

La penisola che ospita lavello e piano cottura si apre al living con con la boiserie a parete attrezzata per ospitare la TV.

A bit kitchen, a bit living room, this is a composition of its kind.

Open and multifunctional, it perfectly embodies the spirit of the entire ARIA project.

The considerable wall unit with glass shelves panelling develops from the eye-level group, Characterized by a clean design, handleless, thanks to the vertical opening system.

The pen-insula with sink and hob opens to the living room with the wall unit panelling to contain the TV.

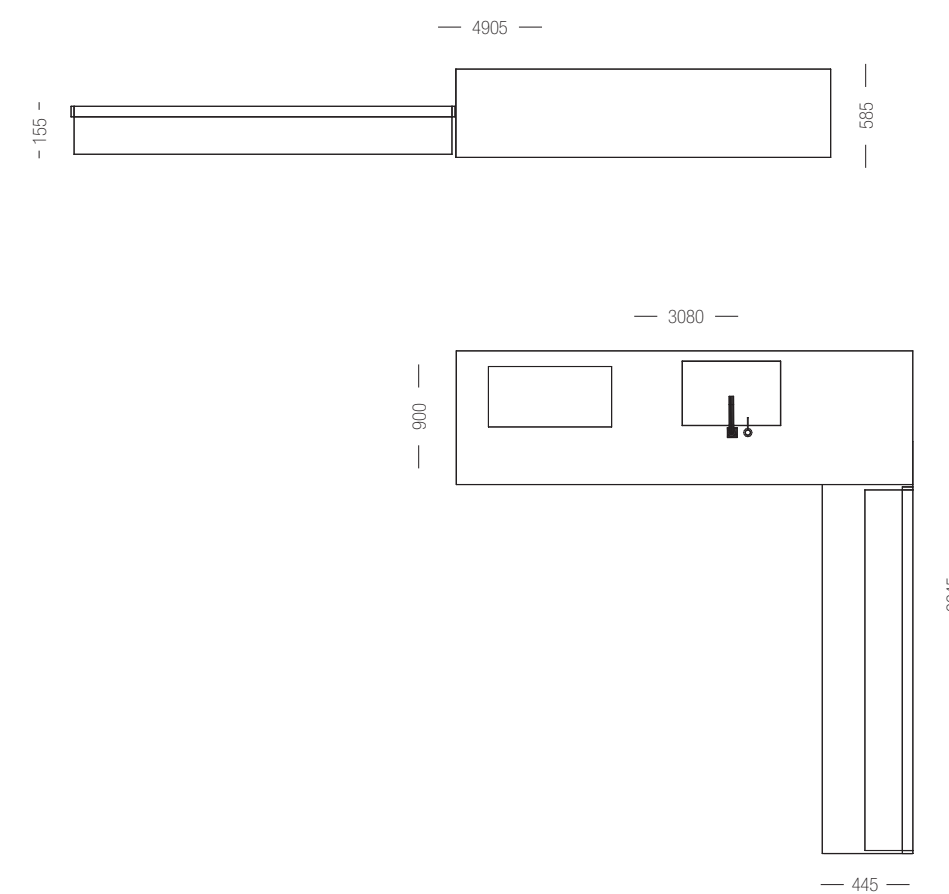





Prevede la massima funzionalità la penisola con top e fianco in Dekton Kelya in cui lavello e piano cottura sono accostati. Situata di fronte al gruppo colonne crea la perfetta zona operativa in cui tutti gli strumenti e l'ampio piano d'appoggio contribuiscono a creare i migliori requisiti per l'esecuzione impeccabile di qualsiasi preparazione culinaria.

It provides maximum functionality thanks to the peninsula with Dekton kelya top and side, near the sink and the hob. Placed opposite the eye-level group, it creates the perfect operational area in which all tools and the wide surface contribute to creating the best requirements for the faultless preparation of any recipe.





A continuazione della penisola si estende un invito alla zona giorno con il sistema autoportante BOISERIE dai sottilissimi ripiani a sbalzo in metallo, allestita con monitor tv integrato.
 Le basi h36 cm forniscono sia un'eccellente piano d'appoggio sia un'ottima soluzione contenitiva.
*The living room is also enhanced by the self-supporting BOISERIE system with slim metal em-bossed shelves, equipped with integrated TV monitor.
 The 36 cm-high bases provide both an excellent support surface and an excellent container solution.*





ARIA 3

LAMINATO PET MATT BIANCO
WHITE PET MATT LAMINATE
 LAMINATO PET MATT FANGO
MUD-COLOURED PET MATT LAMINATE
 BRUNITO
BURNISHED
 LAMINATO PIETRA MARRONE
BROWN STONE TOPCOAT

Si inserisce perfettamente in ambienti aperti in cui le varie zone abitative sono in continua comunicazione.
 ARIA 3 è una composizione dal design geometrico, in cui le linee orizzontali e verticali creano trame che rimandano all'arte astratta. Racchiude notevoli dettagli stilistici che arricchiscono il suo layout lineare, come il blocco cottura su base rialzata e l'altezza considerevole delle colonne che, grazie alla loro verticalità, permettono lo sviluppo armonioso di tutta la composizione.

*It perfectly fits open spaces where the various living areas are in continuous communication.
 ARIA 3 has a geometric design, in which horizontal and vertical lines create weaves that re-call abstract art. It encloses remarkable stylistic details that enrich its linear layout, such as the cooking block on a raised base and the considerable height of the columns that, thanks to their verticality, allow the harmonious development of the entire composition.*

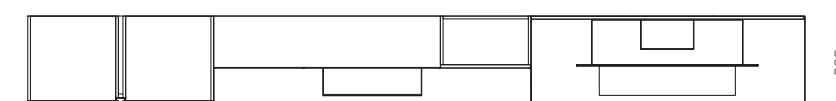
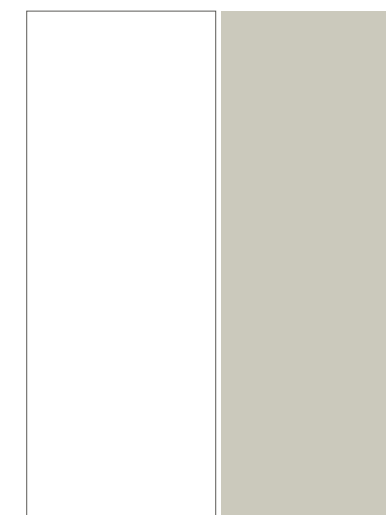

— 5143 —





Il punto focale è concentrato sulla zona che ospita il piano cottura.
Delineato dalla schiena in laminato kali pietra marrone, in continuità con il top, diventa tratto distintivo sia per l'importante cappa con frontale in acciaio spazzolato sia per l'utilizzo del modulo con basi rialzate.

*The focal point focuses on the area that houses the hob.
Characterized by the kali brown stone laminate backside, in continuity with the top, it becomes a distinctive feature both for the large hood with brushed steel front and for the use of the module with raised bases.*





I moduli rialzati di tutta la collezione ARIA poggiano su un telaio in metallo con piedini conici. Il design minimal non interferisce con l'estetica generale della composizione, anzi ne sottolinea l'estrema razionalità e ne rafforza il linguaggio diretto e contemporaneo.

The raised modules of the entire ARIA collection stand on a metal frame with conical feet. The minimal design does not interfere with the overall aesthetics of the composition, but it emphasizes the extreme rationality and strengthens its direct and contemporary language.





ARIA 4

LAMINATO PET MATT LAVAGNA
PET MATT LAVAGNA LAMINATE
 BRUNITO
BURNISHED
 LAMINATO PIETRA GRIGIA
GREY STONE TOPCOAT

Formalmente più rigorosa sia nelle linee sia nell'omogeneità dell'unica finitura, ARIA 4 è un concentrato di raffinata eleganza. Sobria, ma all'avanguardia, supera il concetto di modernità grazie al giusto equilibrio delle proporzioni. Il gruppo colonne, con doppio forno, attrezzato esclusivamente con ante, diventa il punto di riferimento da cui si sviluppano le basi a cestoni rialzate e la serie di pensili con apertura push pull associati ai moduli a giorno AIR.

Formally more rigorous both in lines and in the homogeneity of the only finish, ARIA 4 is a re-fined elegance concentrate. Simple, but at the forefront, it overcomes the concept of modernity thanks to the right balance of proportions. The column group, with double oven, equipped exclusively with doors, becomes the reference point that results in the raised drawer bases and the series of wall units with push pull opening, associated with the AIR open modules.

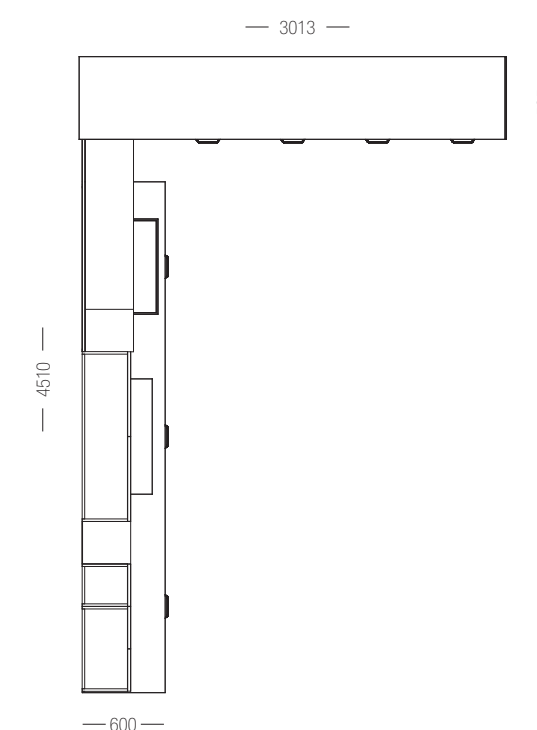





Gli elementi sospesi in metallo AIR, spessore 3 mm, sono aperti lateralmente: questo dettaglio ne facilita sia la componibilità sia crea una variante al classico modulo chiuso enfatizzando così il concetto di leggerezza proprio di tutta la collezione.

The AIR metal suspended elements, with a thickness of 3 mm, are open on the sides: this detail facilitates the modularity and creates a variant of the classic closed module, emphasizing the lightness concept of the entire collection.







I moduli AIR chiusi sono perfetti per essere integrati in composizioni di pensili dove la sottilissima struttura disegna nuove volumetrie all'interno del ritmo uniforme dato dai moduli ciechi. Gli spessori minimi permettono di ridurre l'impatto estetico delle strutture lasciando piena libertà espressiva.

The AIR closed modules are perfect to be integrated into wall units where the very thin structure draws new volumes within the uniform rhythm given by the blind modules. The minimum thicknesses allow to reduce the aesthetic impact of the structures leaving full expressive freedom.



ARIA 5

LAMINATO PET MATT FANGO
 MUD-COLOURED PET MATT LAMINATE
 LAMINATO LARICE CORTINA
 CORTINA LARCH LAMINATE
 METAL
 METAL
 IRIS AVENUE AMBER
 IRIS AVENUE AMBER



ARIA 5 è espressione di un concetto progettuale multilivello per chi chiede alla propria cucina prestazioni oltre gli standard, sia funzionali che estetiche.

Fulcro delle dinamiche abitative si inserisce alla perfezione in contesti open space grazie alla sua versatilità.

Vari elementi sono declinati diversamente, come le mezze colonne rialzate, freestanding, che si alternano alla loro versione integrata nella composizione o come i moduli AIR, aperti e chiusi, impiegati diversamente a seconda delle esigenze compositive.

ARIA 5 is the expression of a multilevel design concept for those who need high functional and aesthetic performance in their kitchen beyond the standards.

Being the heart of housing dynamics, it perfectly fits open spaces thanks to its versatility. Various elements are used differently, such as the free-standing raised half-columns that alternate their version embedded in the composition or the AIR modules, open and closed, used according to the compositional needs.

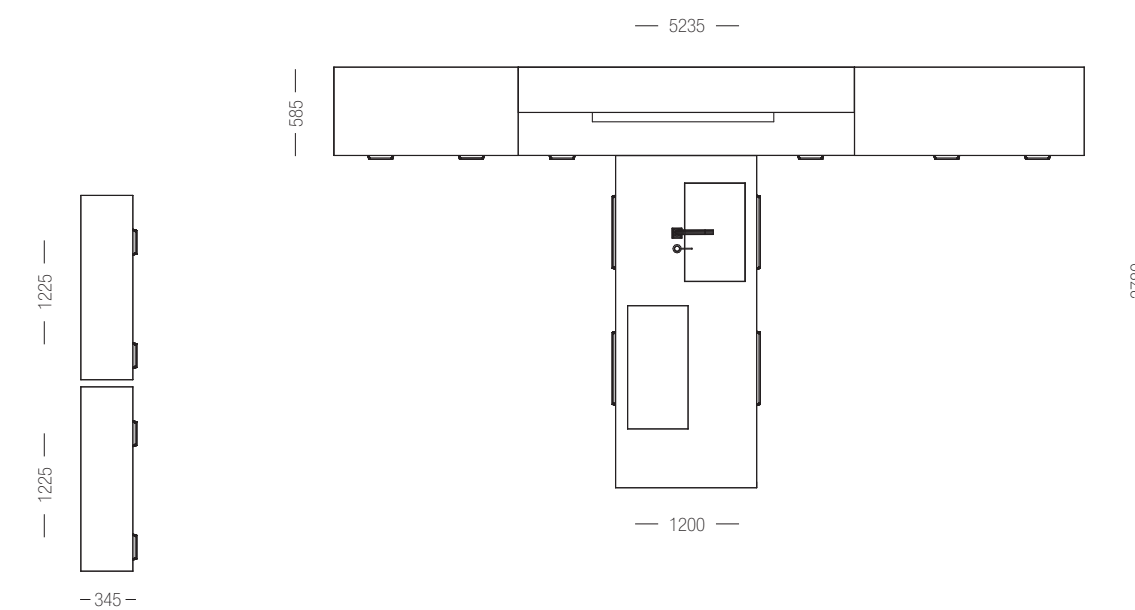





ARIA



Il carattere poliedrico di ARIA 5 posiziona la zona operativa sulla penisola usufruendo di entrambi i lati. Lavello e piano cottura sono contrapposti per una migliore esperienza di utilizzo e un'ottimizzazione più intelligente dello spazio. I classici pensili sono reinterpretati attraverso linee orizzontali da due lunghi ripiani attrezzati con un modulo AIR aperto.

The multifaceted character of ARIA 5 places the operating area on the peninsula using both sides. Sink and hob are opposing for a better user experience and a smarter optimization of the space. The typical wall units are reinterpreted through horizontal lines by two long shelves equipped with an open AIR module.





Le mezze colonne rialzate dal telaio con piedini e associate a moduli a giorno AIR in metallo diventano moderne madie sospese. Racchiuse dai sottili fianchi, nella stessa finitura dell'anta si prestano ad essere ottime basi d'appoggio per gli elementi decorativi grazie all'altezza contenuta.

The half-columns raised by the frame with feet and associated with open AIR metal modules become modern suspended chest. Enclosed by thin sides in the same door finish, they can be a good base for the decorative elements thanks to the low height.

LAMINATO
LAMINATE

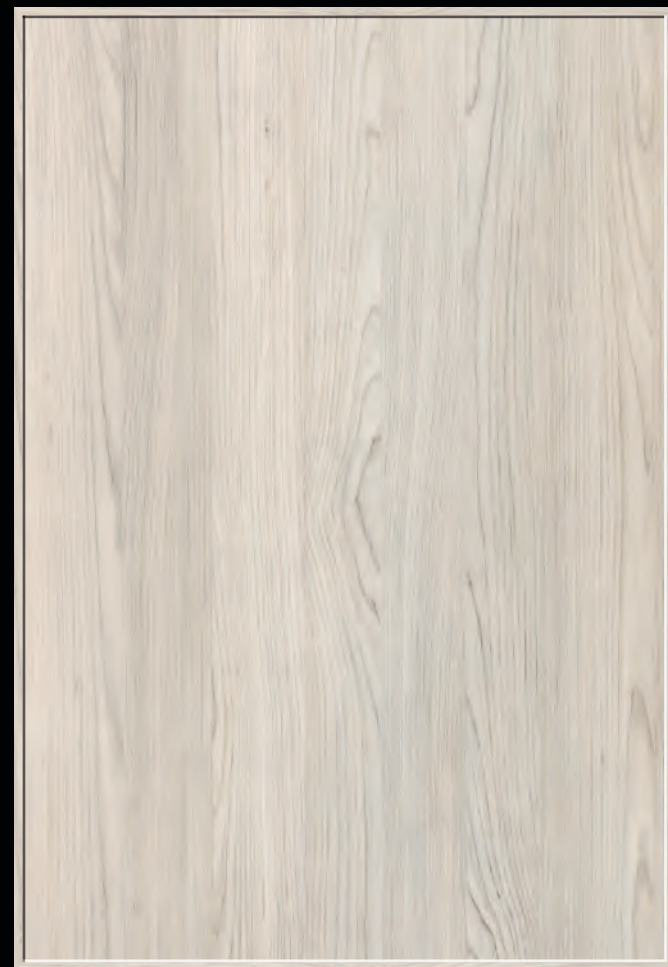

LARICE VAS
VAS LARCH



LARICE CORTINA
CORTINA LARCH

FINITURE E COLORI FINISHES AND COLOURS

I colori delle finiture presenti in questo catalogo sono suscettibili dei procedimenti di stampa. Fa fede il campionario dell'azienda.
The colours of the finishes in this catalogue may be altered by the printing process. Only the company's colour card is valid.

LAMINATO PET LUCIDO
PET GLOSS LAMINATE



BIANCO GLOSS
WHITE GLOSS

LAMINATO PET OPACO
PET MATT LAMINATE

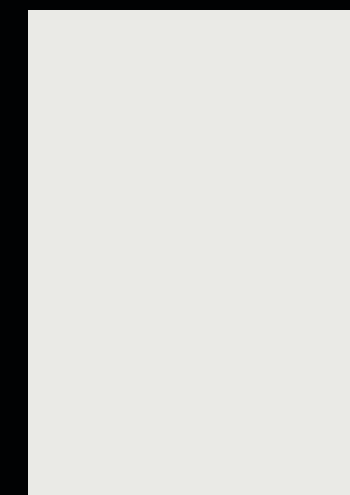

BIANCO MATT
WHITE MATT



FANGO MATT
MUD-COLOURED MATT



LAVAGNA MATT
LAVAGNA MATT

CESTONI CON FRONTE A GIORNO
LACCATI NEI COLORI TIME
LACQUERED DRAWERS WITH OPEN FRONTSIDE
AVAILABLE IN THE TIME COLOURS

ANTE CON CORNICE SOTTILE SP 12mm
DOORS WITH THIN FRAME WITH A 12 MM THICKNESS



NUOVO BASAMENTO RIALZATO IN METALLO H 240 mm
NEW 240MM HIGH METAL RAISED BASE

FIANCHI SOTTILI DA 12 mm
12MM THIN SIDES



AD: STUDIO 28
STAMPA: GRAFICHE ANTIGA



QUALITÀ CERTIFICATA

ARREDO 3 s.r.l. Via Moglianese, 23-30037 Scorzè (Ve)
Tel. 041.5899111 - Fax 041.5899130
www.arredo3.com - arredo3@arredo3.it



L'Azienda da sempre studia le soluzioni compositive secondo criteri di qualità e funzionalità che distinguono la produzione dell'azienda.

L'Azienda garantisce i suoi materiali rivolgendo la sua attenzione all'ambiente, alla vostra salute e alla loro durata nel tempo.

Azienda con sistema qualità certificato UNI EN ISO 9001:2008.

L'Azienda si riserva di introdurre senza preavviso, eventuali modifiche tecnico-costruttive sul prodotto e sulle composizioni presentate

The company designs furnishing solutions in line with the principles of quality and functionality that have always been distinctive of its products.

The Company guarantees its materials and their durability, with special attention to the environment and your health.

The Company has the certification UNI EN ISO 9001:2008.

The Company reserves the right to make any technical-manufacturing changes to the product and the suggested arrangements, without prior notice.

