

# cattelan italia

---

TABLES



TAVOLI - CONSOLLE - CONSOLLE ALLUNGABILI - SCRIVANIE  
TABLES - CONSOLES - EXTENDIBLE CONSOLES - DESKS









2  
LAND AND  
LANDSCAPE  
THE CULTURAL  
ENCOUNTER  
1950-60





# INDEX BOOK 1

## TAVOLI

Dining Tables\_Tables

Mesas\_Tische\_Столы

### PAGE

153	BORA BORA
176	BORA BORA BISTROT
100	CARIOCA
132	CORAL
152	CORTINA
128	DIAPASON
114	DOMINO
84	ELIOT
80	ELIOT KERAMIK
146	ELIOT ROUND
76	ELIOT WOOD
162	ELVIS
160	ELVIS KERAMIK
158	ELVIS WOOD
142	GIANO
138	GIANO KERAMIK
106	GOBLIN
171	HENRY
26	HYSTRIX
170	HUGO BISTROT
66	IKON
110	JEREZ
92	MONACO
116	MUSEUM
166	OBELISCO
154	PEDRO
134	PLISSET
150	RAY
130	REEF
58	RIVER
172	ROGER
174	ROGER KERAMIK
88	SIGMA

### PAGE

50	SKORPIO
42	SKORPIO KERAMIK
144	SKORPIO ROUND
34	SKORPIO WOOD
18	SPYDER
10	SPYDER WOOD
120	VALENTINO
124	VALENTINOX
126	VIOLA D'AMORE
178	XOM KERAMIK

## TAVOLI ALLUNGABILI

Extendible Dining Tables

Tables à rallonges\_Mesas Extensibles

Verlängbare Tische\_Столы с раскладкой

### PAGE

218	AZIMUT
230	BRERA
222	DAYTONA
226	DAYTONA ALMOND
200	ELAN DRIVE
190	ELIOT DRIVE
186	ELIOT KERAMIK DRIVE
182	ELIOT WOOD DRIVE
251	ELVIS DRIVE
250	ELVIS WINGS
238	ELVIS WOOD DRIVE
192	IKON DRIVE
206	JEREZ DRIVE
198	MONACO DRIVE
234	MONDAY
246	NEMO DRIVE
242	PEDRO DRIVE
196	SIGMA DRIVE
212	ZEUS DRIVE
216	ZEUS KERAMIK DRIVE



# INDEX BOOK 1

---

## CONSOLE

Consoles\_Consoles  
Consolas\_Konsolen\_Консоли

### PAGE

278	DIAPASON CONSOLE
279	ELVIS CONSOLE
280	HORIZON
268	MONACO CONSOLE
276	MUSEUM CONSOLE
274	PORTOFINO
272	RAPA NUI
264	TOUR CONSOLE
262	VALENTINO CONSOLE
260	VALENTINOX CONSOLE
255	WESTIN
254	WESTIN WOOD
282	WISH BOARD

## CONSOLE ALLUNGABILI

Extendible Consoles\_Consoles à rallonges  
Consolas Extensibles\_Verlängbare Konsolen  
Консоли с раскладкой

### PAGE

287	CONVIVIAM
300	ELVIS CONSOLE DRIVE
296	NEMO CONSOLE
292	PARTY

## SCRIVANIE

Desks\_Bureaux  
Escritorios\_Schreibtische  
Письменные Столы

### PAGE

320	BATIK
328	DAVINCI
324	DYNO DESK
330	ISLAND
327	LAP
304	NASDAQ
316	QWERTY
322	STORM
310	VEGA











## TAVOLI \_ TABLES



BORA BORA

153



BORA BORA BISTROT

176



CARIOCA

100



CARIOCA

102



ELIOT

84



ELIOT KERAMIK

80



ELIOT ROUND

146



ELIOT WOOD

76



GIANO KERAMIK

138



GOBLIN

106



HENRY

171



HYSTRIX

26



MUSEUM

116



OBELISCO

166



PEDRO

154



PLISSET

134



ROGER KERAMIK

174



SIGMA

88



SKORPIO

50



SKORPIO KERAMIK

42



VALENTINO

120



VALENTINOX

124





CORAL 132

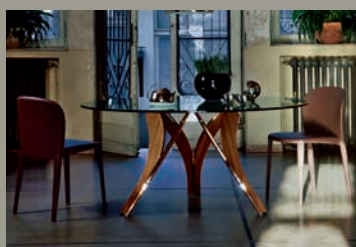

CORTINA 152



DIAPASON 128



DOMINO 114



ELVIS 162



ELVIS KERAMIK 160



ELVIS WOOD 158



GIANO 142



HUGO BISTROT 170



IKON 66



JEREZ 110



MONACO 92



RAY 150



REEF 130



RIVER 58



ROGER 172



SKORPIO ROUND 144



SKORPIO WOOD 34



SPYDER 18



SPYDER WOOD 10



VIOLA D'AMORE 126



XOM KERAMIK 178



## SPYDER WOOD

### Design Philip Jackson

Tavolo con base in acciaio verniciato opaco bianco, nero, graphite, ottone anticato, inox o noce Canaletto.

**Versione "S"** con bordi irregolari in massello in noce Canaletto, rovere bruciato o rovere naturale spessore 4 cm.

**Versione "A"**: piano con bordi obliqui in noce Canaletto, rovere Heritage o rovere naturale, il piano 200x100 ha lo spessore di 4 cm, il 240x120 e il 300x120 di 5 cm.

Table with base in matt white, matt black, matt graphite, brass weathered varnished steel, stainless steel or Canaletto walnut.

4 cm thick top **"S" version** with irregular solid wood edges in Canaletto walnut, burned oak or natural oak.

**Version "A"**: top with angled edges in Canaletto walnut, Heritage oak or natural oak. Wooden top 4 cm on 200x100 version and 5 cm on 240x120 and 300x120 versions.

Table avec base en acier verni blanc mat, noir mat, graphite mat, laiton antique, inox ou noyer Canaletto.

**Version "S"** avec bord irréguliers en bois massif noyer Canaletto, rouvre brûlé ou rouvre naturel en épaisseur 4 cm.

**Version "A"**: plateau en noyer Canaletto, rouvre Heritage ou rouvre naturel avec bords biseauté. Plateau 200x100 avec épaisseur 4 cm, plateaux 240x120 et 300x120 avec épaisseur 5 cm.

Mesa con base en acero lacado blanco mate, negro mate, graphite mate, latón antiguo, acero inox o nogal Canaletto.

Grosor sobre de 4 cm en la **versión "S"** en nogal Canaletto, roble ahumado o roble natural con bordes irregulares en maciso.

**Versión "A"**: sobre en nogal Canaletto, roble Heritage o roble natural con bordes obliquos. Sobre 200x100 con grosor 4 cm, sobre medidas 240x120 y 300x120 grosor 5 cm.

Tisch mit Basis in lackiertem Stahl matt weiss, matt schwarz, matt graphite, Messing antik, Edelstahl oder Nussbaum Canaletto.

**Version "S"** mit irregelmessigen Kanten in massives Holz noce Canaletto oder verbrannte Eiche oder Eiche Natur. Dicke den Platten 4 cm.

**Version "A"**: Platte in Nussbaum Canaletto, Eiche Heritage oder Natur Eiche mit schräge Kanten. Die Platte 200x100 hat 4 cm Dicke, die Platten in 240x120 und 300x120 haben 5 cm Dicke.

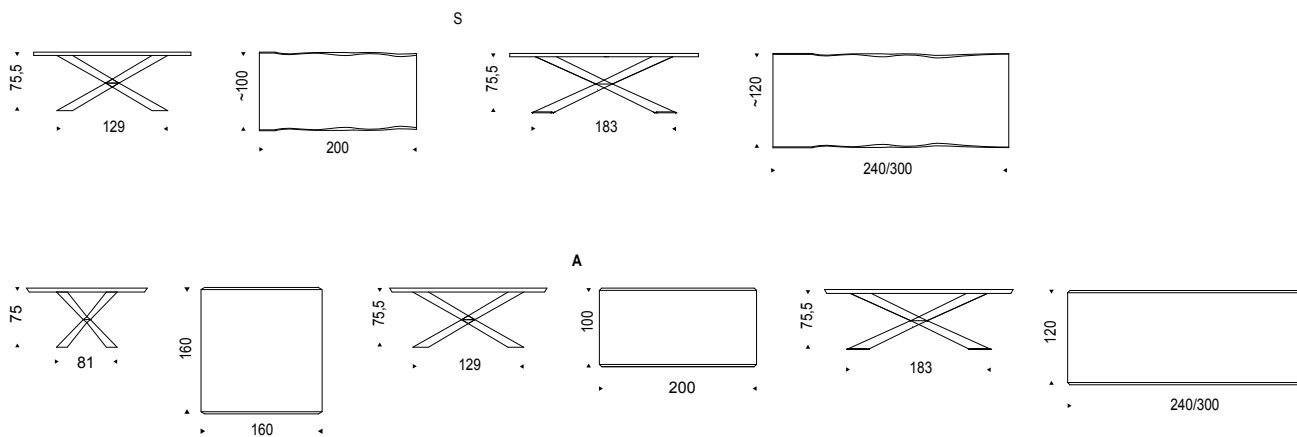

SPYDER WOOD A









table SPYDER WOOD S (Conaletto walnut) - chairs SAMANTHA - lamps VENEZIA - rugs JAIPUR, CHENINAI, DELHI





Opposite of Cold

The Southwestern & French  
— Home Edition —

PROBLEMS



















## SPYDER

### Design Philip Jackson

Tavolo con base in acciaio verniciato opaco bianco, nero, graphite, ottone anticato, inox, graphite, noce Canaletto, inox, noce Canaletto o dark wenghè. Piano in appoggio in cristallo 15mm trasparente o trasparente extrachiaro. I piani 182x90 e 200x106 hanno spessore 12mm. Piccole irregolarità di riflessione sulla base in acciaio sono dovute alla lavorazione manuale.

Table with base in matt white, matt black, matt graphite or brass wheatered varnished steel, stainless steel, Canaletto walnut or dark wenghè. Top in 15mm clear or extra clear glass, laid on the base. Glass top 12mm on 200x106 and 182x90 version. Small reflection's irregularities on the stainless steel base are due to manual processing.

Table avec base en acier verni blanc mat, noir mat, graphite mat, laiton antique, inox, noyer Canaletto ou dark wenghè. Plateau en appui en verre 15mm transparent ou extraclair transparent. Version 182x90 et 200x106 épaisseur 12mm. Les petites irrégularités de réflexion sur la base en acier inox sont dues à une fabrication manuelle.

Mesa con base en acero lacado blanco mate, negro mate, graphite mate, latón antiguo, inox, nogal Canaletto o dark wenghè. Sobre en apoyo en cristal 15mm transparente o transparente extrachiaro. El sobre 182x90 y 200x106 es de 12mm. Pequeñas irregularidades de reflexión en la base de acero inox están causadas por la producción manual.

Tisch mit Basis aus lackiertem Stahl matt weiß, matt schwarz, matt graphite, Messing antik, Edelstahl, Nußbaum Canaletto oder dark wenghè. Transparentes oder Opti-Whitel transparentes Glas 15mm. Die Platte in der Größe 182x90 und 200x106 hat eine Dicke von 12mm. Platte auf dem Basis gelegt. Kleine Unregelmäßigkeiten der Basis in Edlsthäl sind nicht zu vermeiden, da das Teil per Hand hergestellt wird.

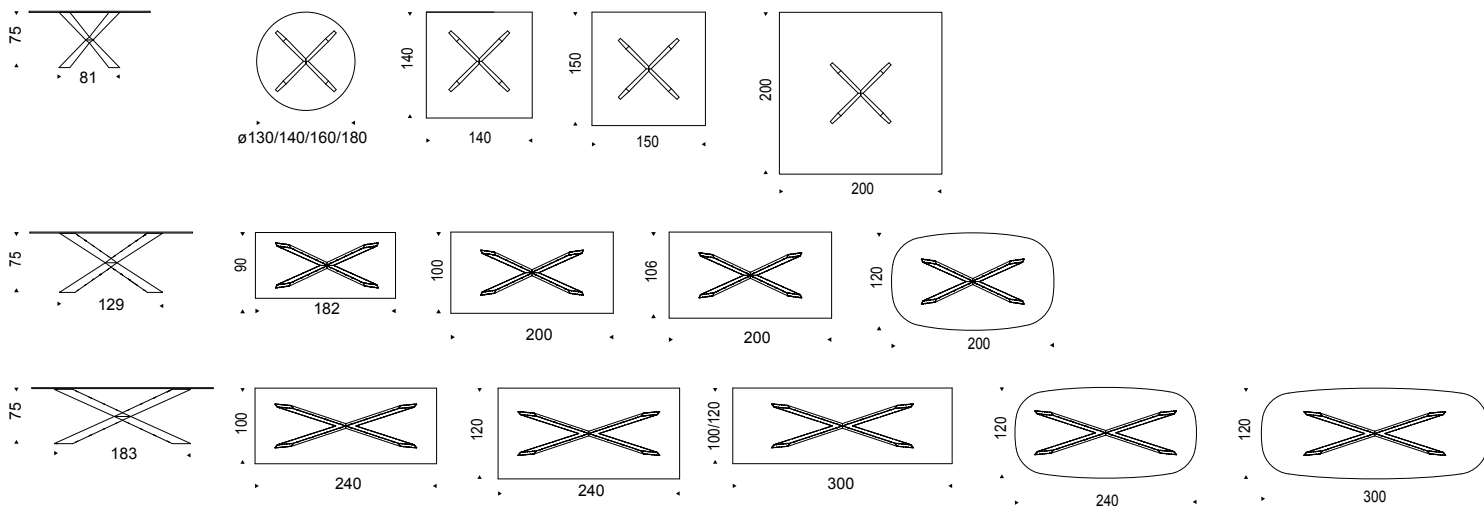























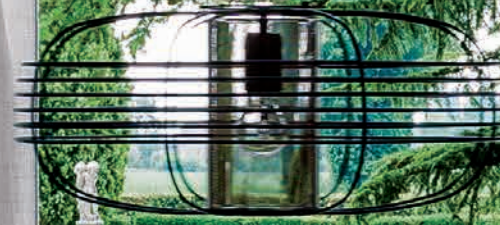
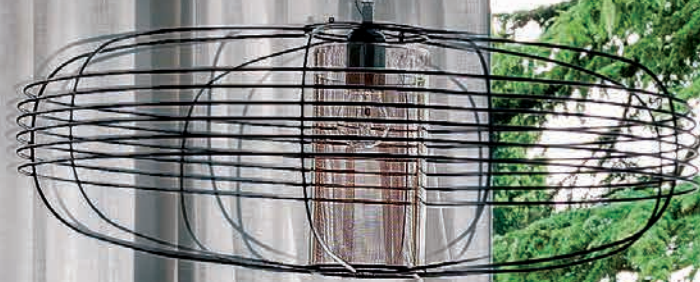







## HYSTRIX

### Design Giorgio Cattelan

Tavolo con base in acciaio verniciato trasparente. Piano in appoggio in cristallo 15mm trasparente, trasparente extrachiaro o trasparente extrachiaro con bordi bisellati inversi. La finitura OPO della base identifica una verniciatura trasparente su materiale ferroso grezzo.

Table with transparent varnished steel base. Top in 15mm clear, extra clear or extra clear glass with reversed bevelled edges. The top is laid on the base. The finish of the base OPO identifies a transparent coating on ferrous raw material.

Table avec base en acier laqué transparent. Plateau en verre clair 15 mm, extra-clair ou extra-clair avec bords biseautés inversés. Plateau d'appui. La finition de la base OPO, identifie un revêtement transparent sur le matériel en fer brut.

Mesa con base en acero barnizado transparente. Sobre en cristal 15mm transparente, transparente extraclaro o transparente extraclaro con bordes biselados inversos. Sobre en apoyo. El acabado OPO de la base identifica una barniz transparente de la materia prima de hierro.

Esstisch mit Basis aus Stahl lackiert transparent. Platte in 15mm Glas transparent, extra hell transparent, oder extra hell mit Kanten umgekehrt facettiert. Platte auf dem Basis gelegt. Die Ausführung der Basis OPO identifiziert eine transparente Beschichtung auf roh Stahl.

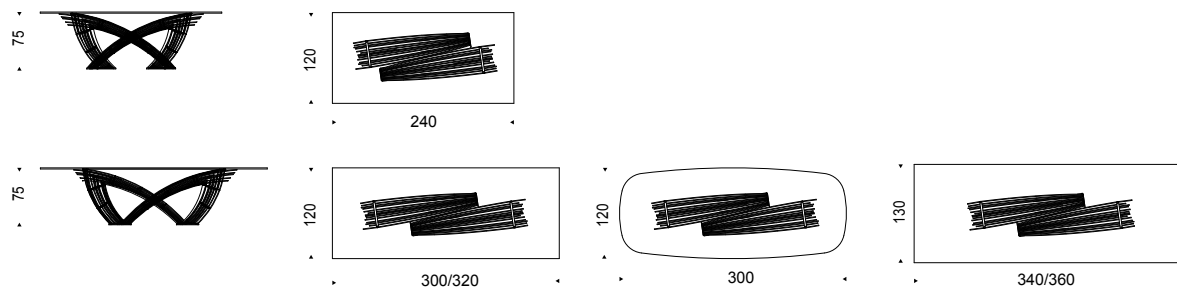





table HYSTRIX - chairs TYLER - lamp CRISTAL - sideboard NEBRASKA





LIFE LANTING













table HYSTRIX - chairs MAGDA B - lamp CRISTAL





NOCE CANALETTO - WALNUT CANALETTO  
TOP VERSION S



ROVERE BRUCIATO - BURNED OAK  
TOP VERSION S





ROVERE HERITAGE - HERITAGE OAK  
TOP VERSION A

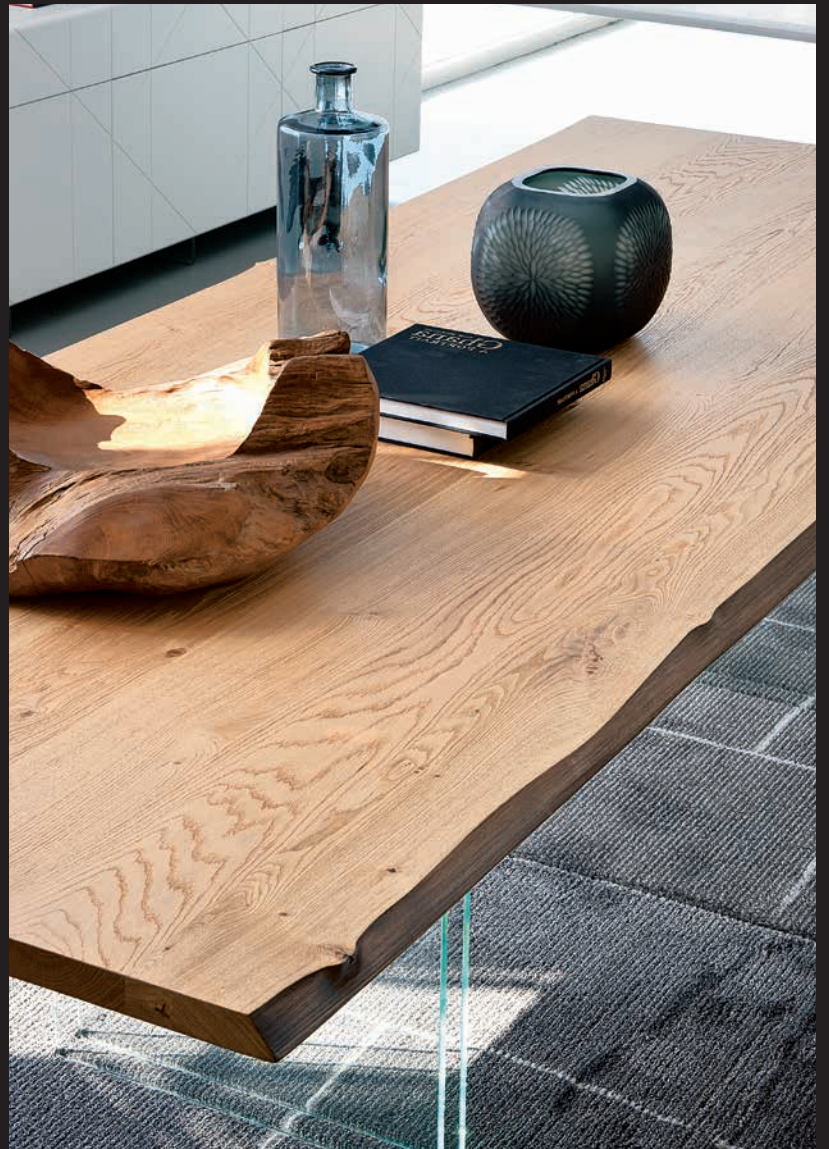

ROVERE NATURALE - NATURAL OAK  
TOP VERSION S



## SKORPIO WOOD

### Design Andrea Lucatello

Tavolo con base in acciaio verniciato trasparente, goffrato embossed lacquered steel or orange fluo. **Versione A:** piano con bordi obliqui in legno noce Canaletto o rovere Heritage, il piano 160x160 e 200x100 hanno lo spessore di 4 cm, il 240x120 e il 300x120 di 5 cm.

**Versione "B":** piano a botte in noce Canaletto, rovere bruciato o rovere naturale con bordi bisellati. **Versione "S":** piano con bordi irregolari in massello di noce Canaletto, rovere bruciato o rovere naturale, spessore 4 cm.

Table with transparent varnished metal base, white, black graphite embossed lacquered steel or orange fluo. **A version:** top with angled edges in Canaletto walnut or Heritage oak.

4 cm thick wooden top on 160x160 and 200x100 versions and 5 cm on 240x120 and 300x120 versions.

**Vesion "B":** barrel top with bevelled edges in Canaletto walnut, burned oak or natural oak.

**Version "S":** top with irregular solid wood edges in Canaletto walnut, burned oak or natural oak, 4 cm thickness.

Table avec base en acier verni transparent, gaufré blanc, noir graphite ou orange fluo.

**Version A:** plateau avec bords biseauté en bois noyer Canaletto ou rouvre Heritage. Les plateaux 160x160 et 200x100 ont une épaisseur de 4 cm, les plateaux 240x120 et 300x120 de 5 cm.

**Version "B":** plateau avec bords biseauté en noyer Canaletto, rouvre brûlé ou rouvre naturel.

**Version "S":** plateau en noyer Canaletto, rouvre brûlé ou rouvre naturel avec bords irréguliers en bois massif. Épaisseur 4 cm.

Mesa con base en acero barnizado transparente, gofrado blanco, negro graphite o naranja fluo. **Versión A:** sobre con bordes oblicuos en nogal Canaletto o roble Heritage. Grosor sobre de 4 cm en las medidas 160x160 cm y 200x100 cm y de 5 cm en las medidas 240x120 cm y 300x120 cm.

**Versión "B":** sobre con bordes biselados en nogal Canaletto, roble ahumado o roble natural.

**Versión "S":** sobre en nogal Canaletto, roble ahumado o roble natural con bordes irregulares en macizo. grosor 4 cm.

Esstisch mit Basis aus Metall lackiert transparent, weiß, schwarz, graphit gaufriert oder orange fluo.

**Version A:** platte mit schräge Kanten in Nussbaum Canaletto oder Eiche Heritage. Die Platten 160x160 und 200x100 sie haben 4 cm Dicke, die Platten in 240x120 und 300x120 haben 5 cm Dicke.

**Version "B":** Platte mit schräge Kanten aus Nussbaum Canaletto, "verbrannte Eiche" oder Natur Eiche.

**Version "S":** Platte in Nussbaum Canaletto, "verbrannte Eiche" oder Natur Eiche mit massiven und unregelmäßigen Kanten. 4 cm Dicke.

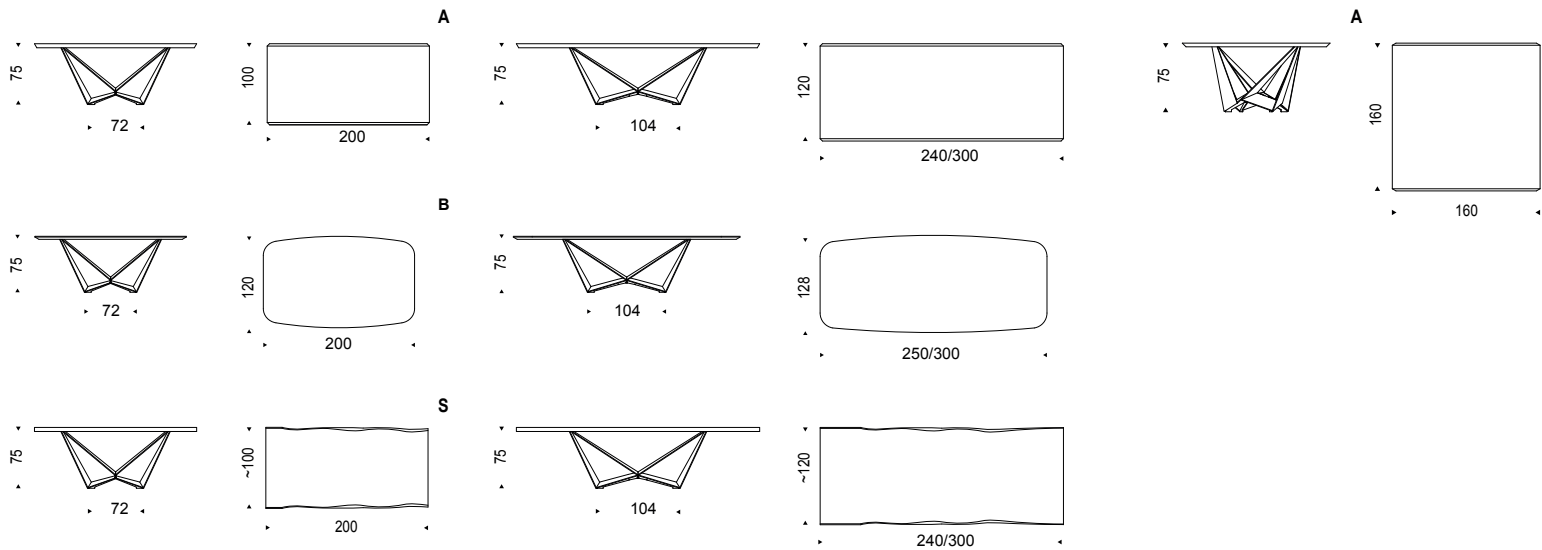





table SKORPIO WOOD B - chairs ARCADIA - lamps VENEZIA - sideboard EUROPA - mirror WISH





















BASE OPO (transparent varnished metal), TOP walnut heritage oak







## SKORPIO KERAMIK

Design A. Lucatello & P. Cattelan

Tavolo con base in acciaio verniciato trasparente, arancio fluo, gofrato bianco, nero o graphite. Piano in ceramica Marmi Calacatta, Alabastro o Ardesia.

Table with transparent varnished metal base, orange fluo, white, black or graphite embossed lacquered steel. Top in ceramic Marmi Calacatta, Alabastro or Ardesia.

Table avec base en acier laqué transparent, orange fluo, gaufré blanc, noir ou graphite. Plateau en céramique Marmi Calacatta, Alabastro ou Ardesia.

Mesa con base en acero barnizado transparente, naranja fluo, gofrado blanco, negro o graphite. Sobre en cerámica Marmi Calacatta, Alabastro o Ardesia.

Esstisch mit Basis aus Metall lackiert transparent, fluo orange oder weiß, schwarz oder graphite gaufriert. Platte in Keramik Marni Calacatta, Alabastro oder Ardesia.

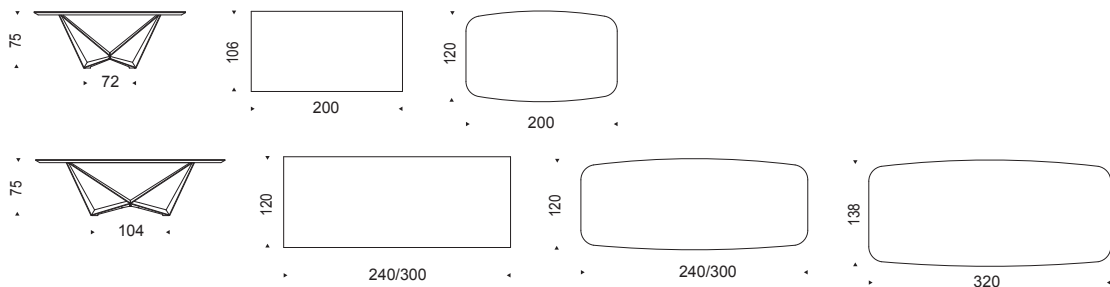

### SKORPIO KERAMIK ROUND

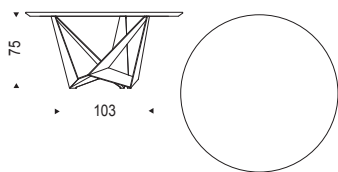

### LAZY SUSAN

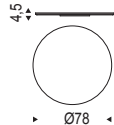































## SKORPIO

### Design Andrea Lucatello

Tavolo con base in acciaio verniciato trasparente, arancio fluo, gofrato bianco, nero o graphite. Piano in cristallo 15mm trasparente, trasparente extrachiaro o trasparente extrachiaro con bordi bisellati inversi. I piani 182x90 e 200x106 hanno spessore 12mm. Piano in appoggio.

Table with transparent varnished metal base, orange fluo, white, black or graphite embossed lacquered steel. Top in 15mm clear, extra clear or extra clear glass with reversed bevelled edges. Glass top 12mm on 182x90 and 200x106 versions. The top is laid on the base.

Table avec base en acier verni transparent, orange fluo, gaufré blanc, noir ou graphite. Plateau en verre clair 15 mm, extra-clair ou extra-clair avec biseautés inversés. Les plateaux 182x90 et 200x106 sont de 12mm. Plateau d'appui.

Mesa con base en acero barnizado transparente, naranja fluo, gofrado blanco, negro o graphite. Sobre en cristal 15mm transparente, transparente extraclaro o transparente extraclaro con bordes biselados inversos. Los sobros 182x90cm y 200x106cm son de 12mm. Sobre en apoyo.

Esstisch mit Basis aus Metall lackiert transparent, orange fluo oder weiß, schwarz oder graphit gaufriert. Platte in 15mm Glas transparent, extra hell transparent, oder extra hell mit Kanten umgekehrt facettiert. Platten in 182x90 und 200x106 haben 12 mm Dicke. Platte auf dem Basis gelegt.

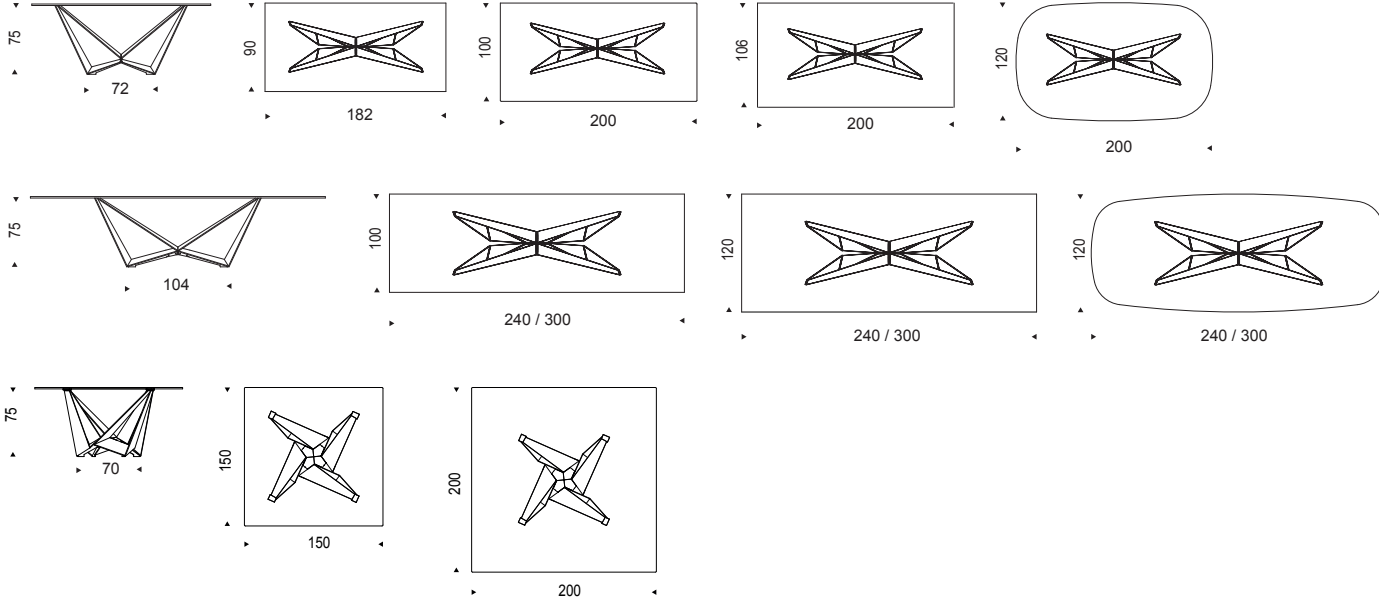





table SKORPIO - chairs ANNA H - lamps GALAXY - mirror EXCALIBUR - sideboard PRISMA

















table SKORPIO (orange fluo) - chairs MAGDA and MAGDA B - lamps DREAM - mirror TAXEDO - sideboard KAYAK









table SKORPIO - chairs LIZ - lamps APOLLO - consolle WESTIN - mirror STRIPES







**RIVER****Design Daniele Molteni**

Tavolo con base in acciaio verniciato gofrato bianco, nero o graphite. Piano in legno noce Canaletto o rovere bruciato con inserto centrale in cristallo extrachiaro stratificato.

Table with base in white, black or graphite embossed lacquered steel. Top in Canaletto walnut or burned oak with central insert in extra clear laminated glass.

Table avec base en acier laqué gaufré blanc, noir ou graphite. Plateau en noyer Canaletto ou rovre brulé avec insert central en verre extra clair stratifié.

Mesa con base en acero barnizado gofrado blanco, negro o graphite. Sobre en madera nogal Canaletto o roble ahumado con detalle central en cristal transparente extraclaro estratificado.

Esstisch mit Basis in Edelstahl lackiert weiß oder graphite gaufriert. Platte in Nussbaum Canaletto oder "verbrannte Eiche" mit Zentraleinsatz aus Glas extrahell geschichtet.

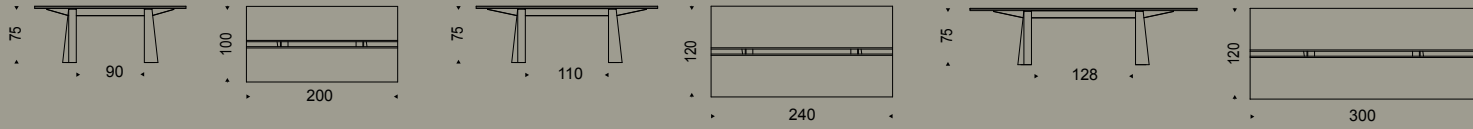

Canaletto walnut









table RIVER (Canaletto) - chairs ARCADIA - lamp ZEPPELIN - sideboard KAYAK









table RIVER (Canaletto) - chairs ISABEL - lamp ZEPPELIN - sideboard KAYAK





burned oak





table RIVER (burned oak) - chairs ARCADIA - lamps HUBLLOT - sideboard PRISMA



## IKON

### Design Philip Jackson

Tavolo con base in cristallo temperato extrachiaro trasparente 15mm e trave in graphite. Piano in noce Canaletto, rovere bruciato o rovere naturale con bordi irregolari in massello. Disponibile anche trave in noce Canaletto, rovere bruciato o rovere naturale.

Table with 15mm extraclear tempered glass base and graphite beam. Top in solid Canaletto walnut, burned oak or natural oak with irregular solid wood edges. Available also Canaletto walnut, burned oak or natural oak beam.

Table avec piètement en verre trempé extra-clair transparent 15mm et traverse en graphite. Plateau en noyer Canaletto, rovre brulé ou rovre naturel. Bords irréguliers en bois massif. Disponible aussi traverse en noyer Canaletto, rovre brulé ou rovre naturel.

Mesa con base en cristal templado extraclaro transparente 15mm y viga en graphite. Sobre en nogal Canaletto, roble ahumado o roble natural con bordes irregulares en macizo. Disponible también viga en nogal Canaletto, roble ahumado o roble natural.

Esstisch mit Basis aus 15mm extra hell transparentem gehärtetem Glas und Holm aus graphite. Platte aus Nussbaum Canaletto, "verbrannte Eiche" oder Eiche Natur mit massiven Kanten. Holm aus Nussbaum Canaletto, "verbrannte Eiche" oder Eiche Natur verfügbar.

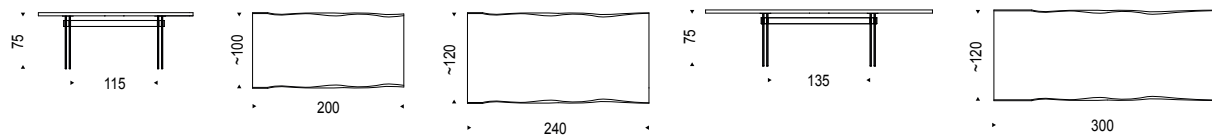

### IKON DRIVE → EXTENDABLE TABLE pag. 192

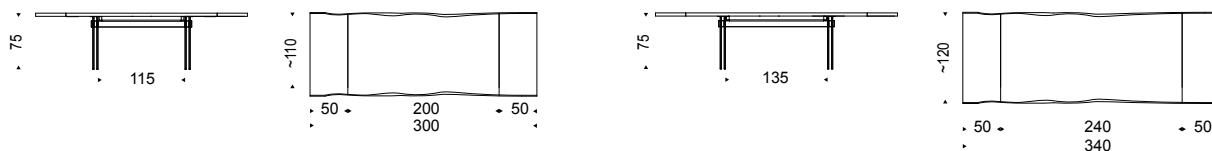

















table IKON (burned oak) - chairs MUSA B - lamps CRISTAL





burned oak





DAYTONALMONDZED  
ELIOTWOODRIVELP  
HUGOBISTROTFLAG  
MONACODRIVEANNA  
MONTECARLOJEREZ  
HELENAISABELMIA  
DOMINONEBRASKAU  
SMARTBALOONLARA  
OTCALIMEROO  
OASTRAARCR  
TMONDAYRAYO  
DNGOHYATTRR  
RAMAMATISSE  
TINOELVISR  
REGALZENITH  
TINAVENELAP  
RINTHWERTY  
RILWINDOWTV  
ONPARSIFAL  
LITTLEFLAGM  
YWOODFUT  
ANDTHRIL  
TCOBRAI

RAYATISSER  
ALVISSR  
ZENITH  
ENELAP  
QWERTY  
NDOWTV  
RSIFAL  
EFLAGM  
FUTURAR  
RILLEX

Castello di Ama





table IKON (natural oak) - chairs ARCADIA and AGATHA FLEX SUM - lamps BOLERO and ZEPPELIN - sideboard TROPEZ - bookcase LOFT











**ELIOT WOOD**

**Design Giorgio Cattelan**

Tavolo con base in acciaio verniciato gofrato bianco, nero, graphite o inox satinato. Piano in legno noce Canaletto, rovere bruciato o rovere naturale con bordi irregolari in massello.

Table with base in white, black or graphite embossed lacquered steel or in satin stainless steel. Top in Canaletto walnut, burned oak or natural oak with irregular edges.

Table avec base en acier inox mat ou gaufré verni blanc, noir ou graphite. Plateau en noyer Canaletto, rouvre brulé ou rouvre naturel avec bords irréguliers en bois massif.

Mesa con base en acero inox satinado o barnizado gofrado blanco, negro o graphite. Sobre en madera nogal Canaletto, roble ahumado o roble natural con bordes irregulares en macizo.

Esstisch mit Basis in Edelstahl lackiert weiss, schwarz oder graphite gaufriert oder in Edelstahl gebürstet. Platte in Nussbaum Canaletto, "verbrannte Eiche" oder Eiche Natur mit massiven Kanten.

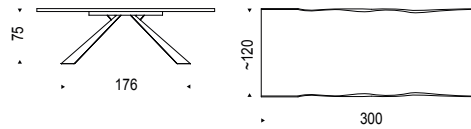
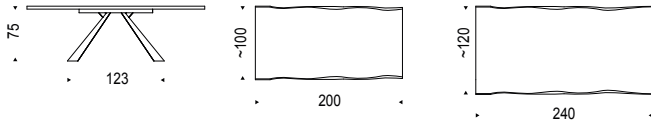

ELIOT WOOD DRIVE → EXTENDABLE TABLE pag. 182

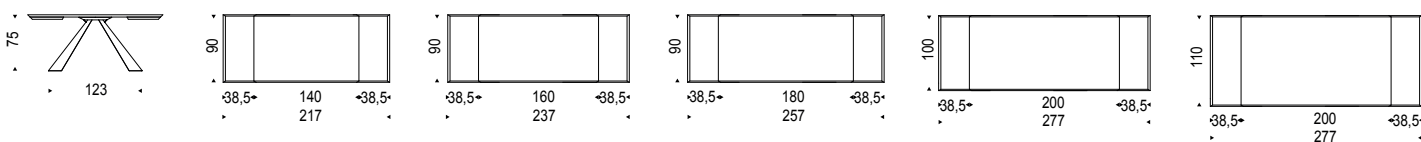















## ELIOT KERAMIK

### Design Giorgio Cattelan

Tavolo con base in acciaio verniciato gofrato bianco, graphite, nero o inox satinato. Piano in ceramica Marmi Calacatta, Alabastro o Ardesia.

Table with base in white, black or graphite embossed lacquered steel or in satin stainless steel. Marmi Calacatta, Alabastro or Ardesia ceramic top.

Table avec base en acier laqué gaufré blanc, noir, graphite mat ou inox satiné. Plateau en céramique Marmi Calacatta, Alabastro ou Ardesia.

Mesa con base en acero barnizado gofrado blanco, negro, graphite o inox satinado. Sobre en cerámica Marmi Calacatta, Alabastro o Ardesia.

Esstisch mit Basis in Edelstahl lackiert weiß, schwarz oder graphite gaufriert oder in Edelstahl gebürstet. Platte in Keramik Marmi Calacatta, Alabastro oder Ardesia.

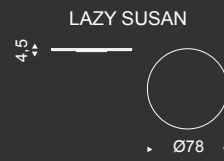
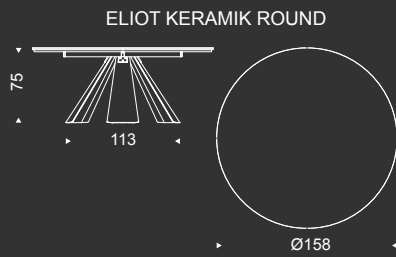
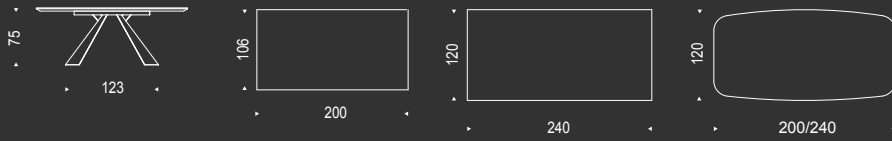

## ELIOT KERAMIK DRIVE → EXTENDABLE TABLE pag. 186

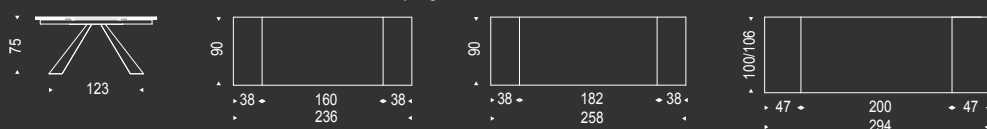









HADITER  
ECOLOGIQUE











**ELIOT**

**Design Giorgio Cattelan**

Tavolo con base in acciaio verniciato gofrato bianco, graphite, nero o inox satinato. Piano in cristallo 12mm extrachiaro verniciato bianco o graphite, extrachiaro acidato bianco o graphite, in marmo bianco Carrara o Emperador. Il piano in cristallo 240x120 ha spessore 15mm.

Table with base in white, black or graphite embossed lacquered steel or in satin stainless steel. 12mm top in white or graphite painted extra clear glass or white or graphite painted frosted extra clear glass or white Carrara or Emperador marble. 15mm glass top on 240x120 version.

Table avec base en acier gaufré verni blanc, noir, graphite ou inox mat. Plateau en verre 12mm extra-clair verni blanc ou graphite, extra-clair dèpoli verni blanc ou graphite, en marbre blanc Carrara ou Emperador. Version 240x120 épaisseur 15mm.

Mesa con base en acero barnizado gofrado blanco, negro, graphite o inox satinado. Sobre en cristal 12mm extraclaro barnizado blanco o graphite o extraclaro translúcido barnizado blanco o graphite, en mármol blanco Carrara o Emperador. El sobre en cristal 240x120 es de grosor 15mm.

Esstisch mit Basis in Edelstahl lackiert weiss, schwarz oder graphite gaufriert oder in Edelstahl gebürstet. Platte in Glas 12mm extra hell lackiert weiss oder graphite, Glas extra hell geätzt weiss oder graphite lackiert oder in weiss Carrara oder Emperador Marmor. Die Platte in der Größe 240x120 hat eine Dicke von 15mm.

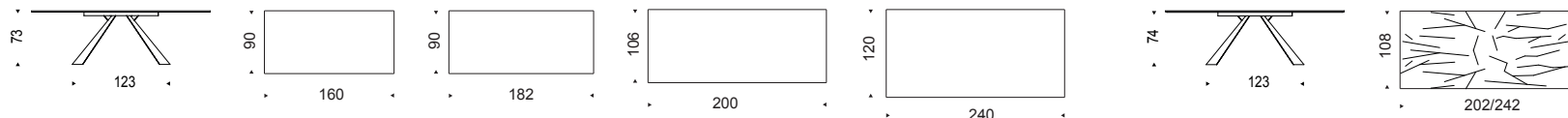

ELIOT DRIVE → EXTENDABLE TABLE pag. 190

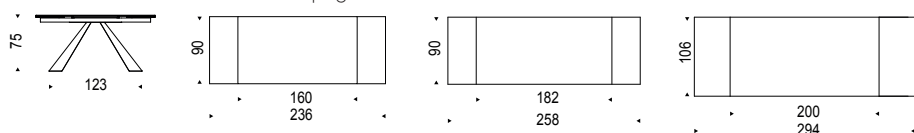











## SIGMA

### Design Philip Jackson

Tavolo con base in metallo verniciato trasparente. Piano in noce Canaletto, rovere bruciato o rovere naturale con bordi irregolari in massello. A richiesta possibilità di posizionare le gambe in parallelo o perpendicolari fra loro.

Table with transparent varnished metal base. Top in Canaletto walnut, burned oak or natural oak with solid irregular edges. Legs can be placed in parallel or in perpendicular to each other on demand.

Table avec base en metal verni transparent. Plateau en noyer Canaletto, rovere brulé ou rovere naturel. Bords irréguliers. Possibilité de positionner les pieds en parallèle ou perpendiculaire entre eux sur demande.

Mesa con base en metal barnizado transparente. Sobre en nogal Canaletto, roble ahumado o roble natural con bordes irregulares en macizo. Posibilidad de colocar las patas en paralelo o perpendiculares entre sí a pedido.

Tisch mit Basis aus Metall lackiert transparent. Platte aus Nussbaum Canaletto, "verbrannte Eiche" oder Natur Eiche mit massiven Kanten. Beine können entweder parallel oder senkrecht montiert werden auf Anfrage.

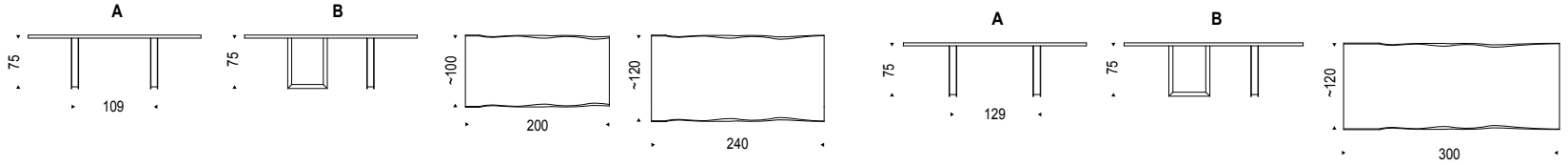

SIGMA DRIVE → EXTENDABLE TABLE pag. 196

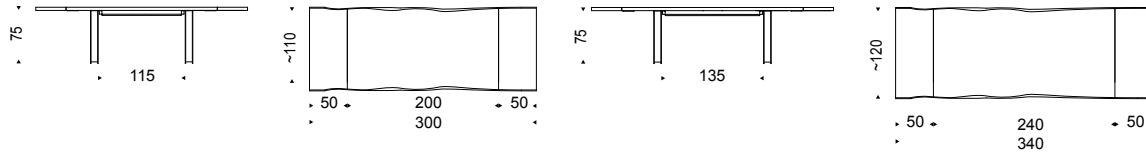

table SIGMA - chairs PATRICIA - sideboard TROPEZ - lamps CALIMERO - mirror JERSEY









DAYTONALMONDZED  
ELIOTWOODRIVELP  
HUGOBISTROTFLAG  
MONACODRIVEANNA  
MONTECARLOJEREZ  
HELENAISABELMIA  
DOMINONEBRASKAU  
SMARTBALOONLARA  
MARGOTCALIMEROO  
ATOLLOASTRAARCR  
GHOSTMONDAYRAYO  
BOBBONGOHYATTRR  
PANORAMAMATISSE  
VALENTINOELVISF  
VITAREGALZENIT  
RCORTINAVENELAF  
LABYRINTHWERTY  
ESTORILWINDOWTV  
HOUSTONPARSIFAL  
LARALITTLEFLAGM  
BILLYWOODFUTURA  
RISLANDTHRILLER  
AZIMUTCORAINOX







table SIGMA (Canaletto walnut) - chairs TOSCA, MAGDA, ARCADIA, HELENA, MADGA B - lamps HUBLLOT - mirror STRIPES - sideboard TORINO - table lamp MEDUSA - bookcase WALLY B



**MONACO**

**Design Giorgio Cattelan**

Tavolo con base in noce Canaletto, rovere bruciato, marmo bianco Carrara o acciaio inox. Piedi in acciaio inox lucido. Piano con piastre in cristallo trasparente temperato 15mm o in marmo bianco Carrara. Piano in marmo in appoggio.

Table with base in Canaletto walnut, burned oak, white Carrara marble or stainless steel. Feet in polished stainless steel. Top with plates in 15mm tempered clear glass or in white Carrara marble. The marble top is laid on the base.

Table avec base en noyer Canaletto, rouvre brûlé marbre blanc Carrara ou acier inox. Pieds en acier inox brillant. Top avec plates en verre clair trempé 15mm ou blanc Carrara. Plateau en marbre d'appui.

Mesa con base en nogal Canaletto, roble ahumado, blanco Carrara o acero inox. Patas en acero inox brillo. Sobre con pletinas en cristal transparente templado 15mm o en blanco Carrara. Sobre en mármol en apoyo.

Tisch mit Basis aus Nussbaum Canaletto, "verbrannte Eiche", weißem Carrara Marmor oder Edelstahl. Füße aus poliertem Edelstahl. Platte mit metalplättchen aus Sicherheitsglas transparent 15mm oder in weißem Carrara Marmor. Marmor Platte auf dem Basis gelegt.

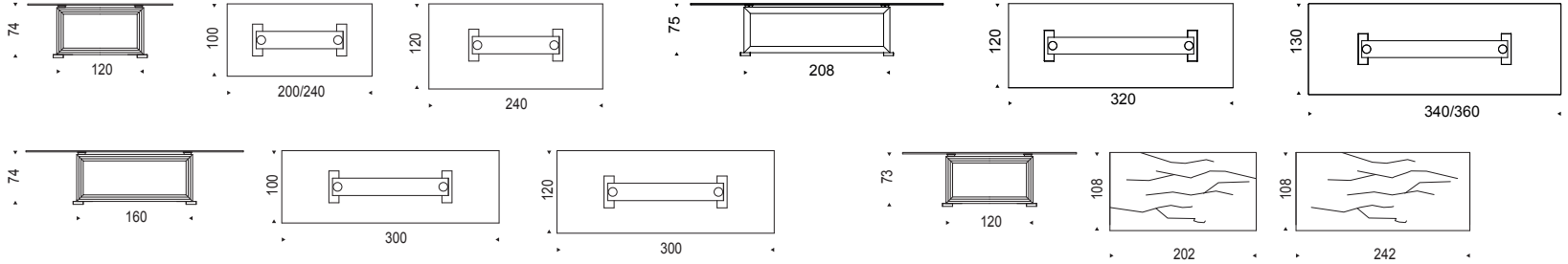

MONACO DRIVE pag. 198

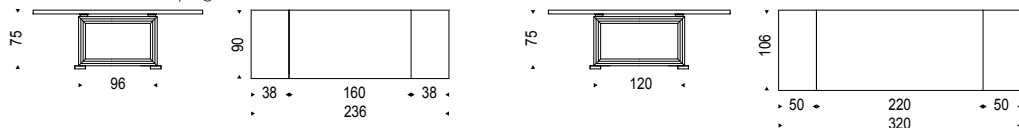





table MONACO - chairs MARGOT H - lamps VENEZIA













base WALNUT CANALETTO



base WHITE CARRARA MARBLE















## CARIOCA

### Design Andrea Lucatello

Tavolo con base in massello di noce Canaletto. Piano con piastre in cristallo 15mm trasparente o trasparente extrachiaro con bordo bisellato.

Table with base in solid Canaletto walnut wood. Top with plates in 15mm clear glass or extra clear bevelled glass.

Table avec base en noyer Canaletto massif. Plateau avec plates en verre, transparent ou extra-clair transparent biseauté 15mm.

Mesa con base de madera maciza en nogal Canaletto. Sobre con pletinas en cristal de 15mm transparente o transparente extraclaro con borde biselado.

Esstisch mit Basis in Nussbaum Canaletto massiv. 15 mm Platte mit metalplättchen aus transparentem oder extra hell transparentem Glas mit facettierten Kanten.

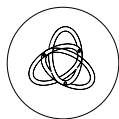
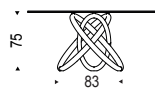

Ø130/140/160/180

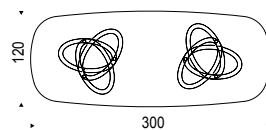
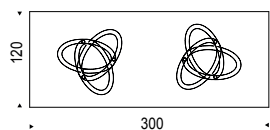
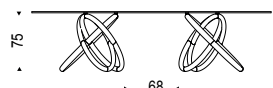























## GOBLIN

### Design Modus Studio

Tavolo con base in massello di noce Canaletto. Piano in appoggio in cristallo trasparente 15mm. Il piano 200x106 ha spessore 12mm.

Table with base in solid Canaletto walnut. Top in 15mm clear and extra clear glass, laid on the base. 12mm glass top on 200x106 version.

Table avec piètement en noyer Canaletto. Plateau en appui en verre transparent ou extra-clair transparent 15mm. Version 200x106 épaisseur 12mm.

Mesa con base maciza en nogal Canaletto. Sobre en apoyo cristal transparente 15mm. El sobre 200x106 es de grosor 12mm.

Tisch mit Basis in Nußbaum Canaletto massiv. Gelegte Platte in Klarglas 15mm. Die Platte in der Größe 200x106 hat eine Dicke von 12mm.

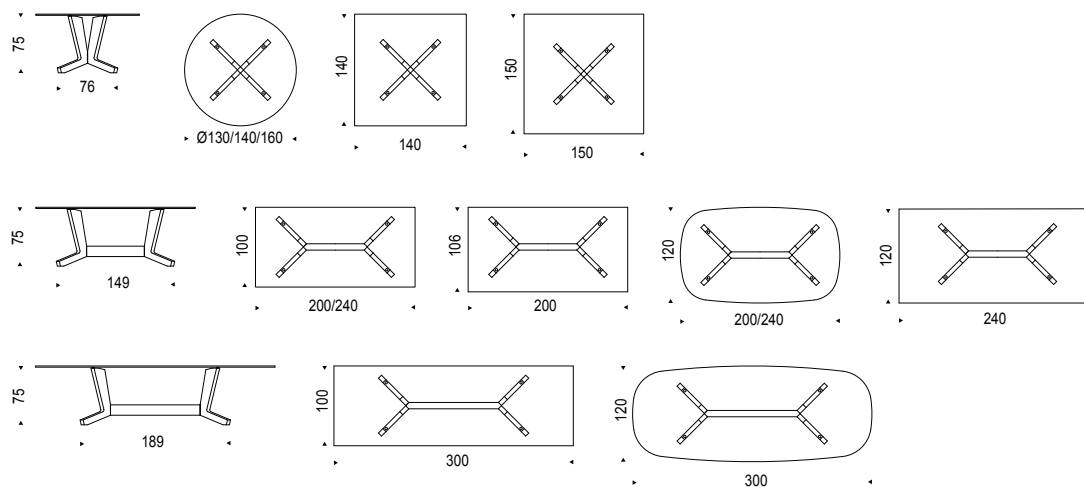

table GOBLIN - chairs ARCADIA H - lamps ECLIPSE - sideboard ARABESQUE















## JEREZ

### Design Alberto Danese

Tavolo con base in acciaio verniciato gofrato bianco, nero o graphite e trave centrale in massello naturale di noce Canaletto o acciaio verniciato gofrato bianco, nero o graphite. Piano in cristallo trasparente o trasparente extrachiaro spessore 1.5mm. Piano in appoggio.

Table with base in white, black or graphite embossed lacquered steel and central beam in natural solid Canaletto walnut or embossed white, black, graphite lacquered steel. Top in 1.5mm clear or extra clear glass. The top is laid on the base.

Table avec base en acier gaufré verni blanc, noir ou graphite avec poutre centrale en bois de noyer Canaletto massif ou en acier gaufré verni blanc, noir ou graphite. Plateau en appui en verre transparent ou extra-clair transparent, épaisseur 1.5mm.

Mesa con base en acero barnizado gofrado blanco, negro o graphite y viga central en macizo natural de nogal Canaletto o acero barnizado gofrado blanco, negro o graphite. Sobre en cristal transparente o transparente extrachiaro 1.5mm. Sobre en apoyo.

Esstisch mit Basis in Edelstahl lackiert weiss, schwarz oder graphite gaufriert und Holm aus massivem Natur Nussbaum Canaletto oder gaufriertem Stahl weiß, schwarz oder graphite. Platte in transparentem Glas oder Glas extra hell. Die Platte in 1.5mm ist auf die Basis gelegt.

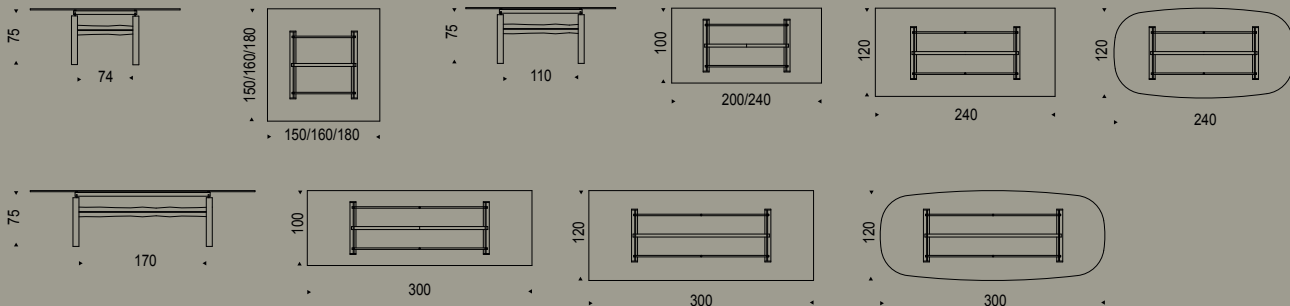

### JEREZ DRIVE → EXTENDABLE TABLE pag. 206

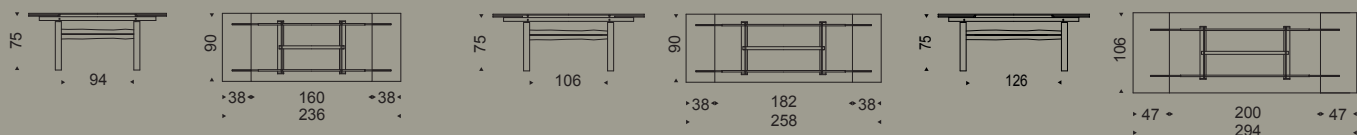





table JEREZ - chairs ISABEL - lamps CALIMERO - sideboards TROPEZ











## DOMINO

### Design Andrea Lucatello

Tavolo con base in massello di noce Canaletto o frassino tinto rovere bruciato, mix nocerovere o laccato a poro aperto in multicolor dall'oyster al graphite. Piano con piastre in cristallo trasparente o trasparente extrachiaro 12mm.

Table with base in solid Canaletto walnut wood or burned oak stained ashwood, mix walnut/oak or multicoloured open pore painting from oyster to graphite. Top with plates in 12mm clear or extra clear glass.

Table avec base en noyer Canaletto massif ou en frêne teinté rouvre brûlé, mix noyer rouvre ou laqué pore-ouvert en multicolore de oyster jusqu'à graphite. Plateau avec plates en verre transparent ou extra-clair transparent 12mm.

Mesa con base de madera en nogal Canaletto o fresno barnizado roble ahumado, mix nogal-roble o barnizado a poro abierto en multicolor de oyster a graphite. Sobre con pletinas en cristal de 12mm transparente o transparente extraclaro.

Esstisch mit Basis aus massiv Nussbaum-Canaletto oder Esche "verbrannte Eiche" gebeizt oder mix Nussbaum-Eiche oder offenporig lackiert in Multicolor oyster, graphite usw. Platte mit metalplättchen aus transparentem oder extra hell transparentem Glas 12mm.

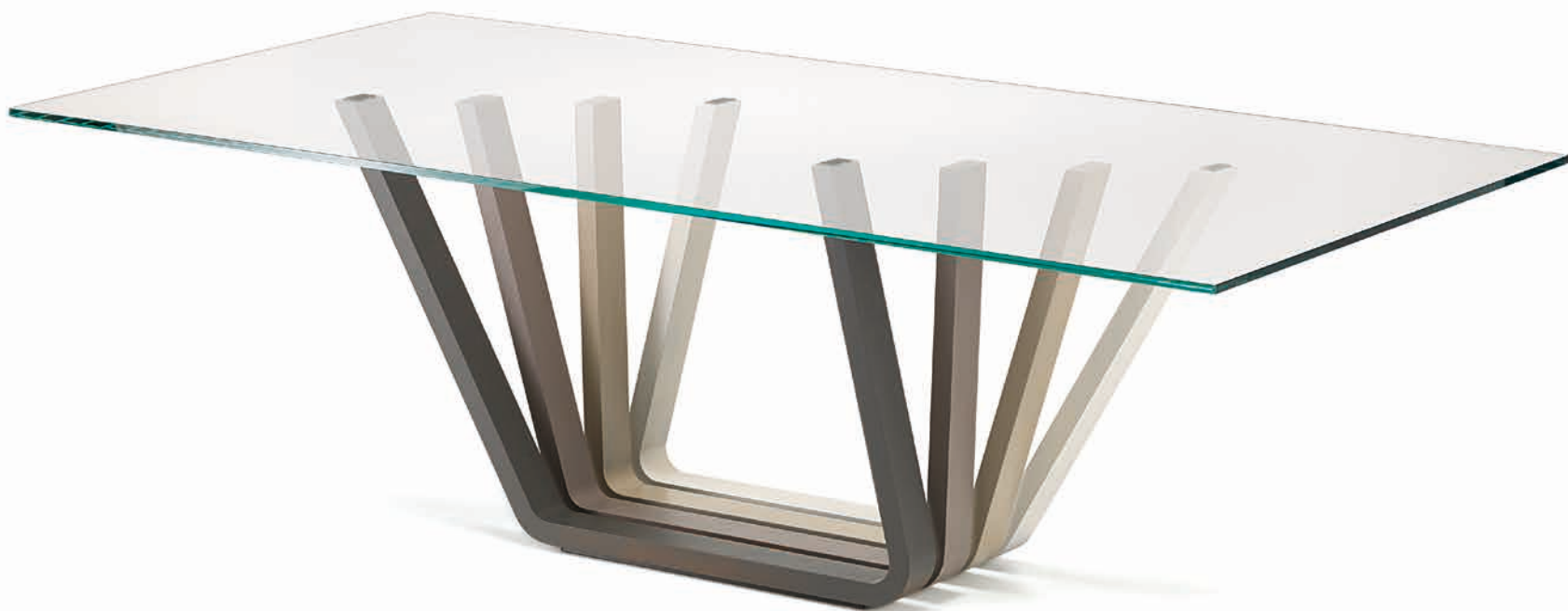
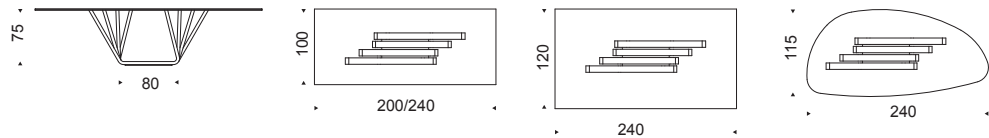







## MUSEUM

Design **G. Cattelan & A. Lucatello**

Tavolo con base in acciaio verniciato trasparente, ramato, gofrato bianco o graphite. Cilindro in marmo bianco Carrara o Travertino naturale. Piano in cristallo trasparente 15mm.

Table with base in transparent varnished steel, copper, embossed white or graphite lacquered steel. Cylinder in natural Travertine or white Carrara marble. 15mm clear glass top.

Table avec base en acier verni transparent, cuivre, gaufré blanc ou graphite et cylindre en marbre Travertin ou blanc Carrara. Plateau en verre clair 15 mm.

Mesa con base en acero barnizado transparente, cobre, gofrado blanco o graphite. Cilindro en mármol Travertino o blanco Carrara. Sobre en cristal 15mm transparente.

Esstisch mit Basis aus Metall lackiert transparent, verkupfert oder weiß oder graphite gaufriert. Zylinder aus Travertin oder weißem Carrara Marmor. Platte 15mm in Glas transparent.

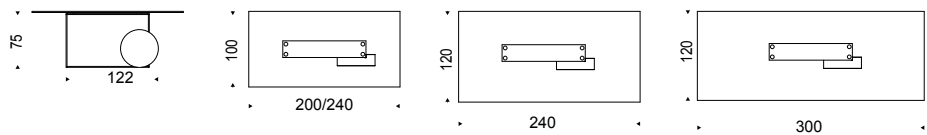









table MUSEUM - chairs MULAN - lamps MIDDAY - sideboard OXFORD 4







## VALENTINO

### Design Emanuele Zenere

Tavolo con base in noce Canaletto o rovere bruciato e cilindro in Travertine, black Marquina o bianco Carrara. Piani in appoggio in cristallo trasparente spessore 15mm. Il piano 240x115 sagomato ha spessore 12mm.

Table in Canaletto walnut or burned oak and cylinder in Travertine, black Marquina or white Carrara marble. Top in 15mm clear glass, laid on the base. The shaped top 240x115 is 12mm thick.

Table avec base en noyer Canaletto ou rouvre brulé et cylindre en Travertin, marbre noir Marquina ou blanc Carrara. Les plateaux sont en verre clair placés sur la base épaisseur 15mm. Le plateau façonné en 240x115 a une épaisseur de 12mm.

Mesa con base en nogal Canaletto o roble ahumado. Cilindro en mármol Travertino, negro Marquina o blanco Carrara. Sobre en apoyo en cristal transparente de 15mm. El sobre 240x115 perfilado es 12mm.

Esstisch mit Basis aus Nussbaum Canaletto oder "verbrannte Eiche". Zylinder aus Travertin, schwarzem Marquina oder weißem Carrara Marmor. Platte aus Klarglas auf die Basis gelegt. Glas Stärke 15mm. Die gemodelte Platte 240x115 ist 12mm dick.

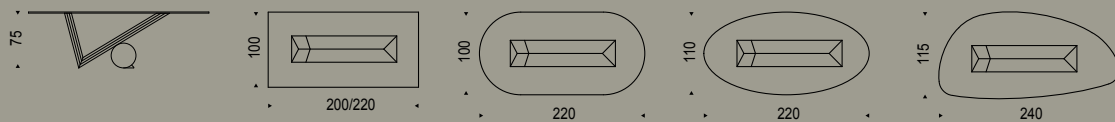



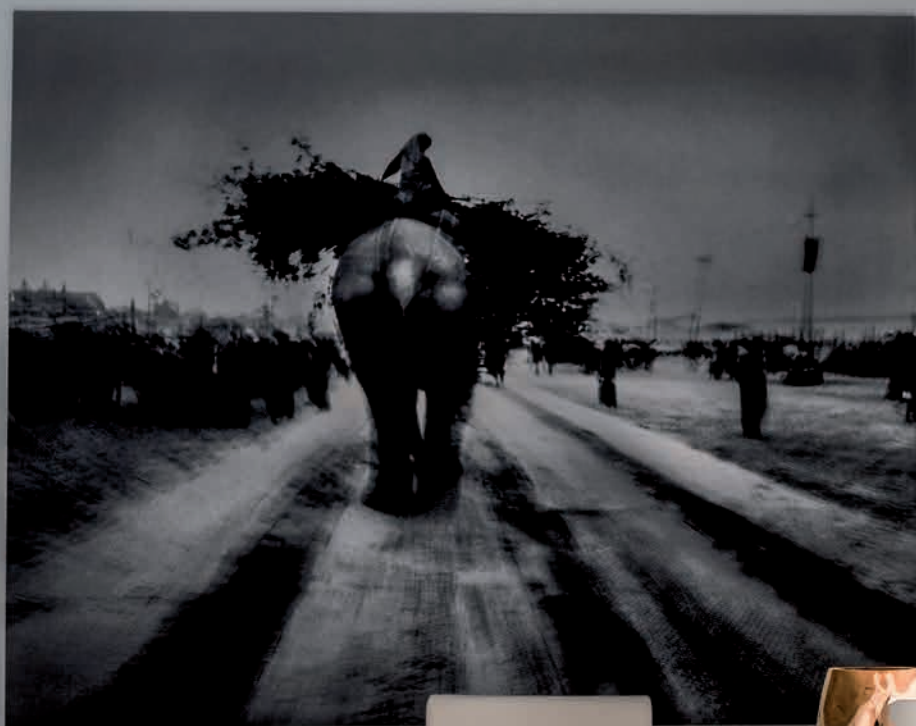











## VALENTINOX

### Design Emanuele Zenere

Tavolo con base in acciaio inox lucido. Cilindro in Travertino, marmo nero Marquina o bianco Carrara. Piani in appoggio in cristallo trasparente spessore 15mm. Il piano 240x115 sagomato ha spessore 12mm. Piccole irregolarità di riflessione sulla base sono dovute alla lavorazione manuale.

Dining table with polished stainless steel base and cylinder in Travertine, Black Marquina or white Carrara marble. Laying clear glass top 15 mm thick. The shaped top 240x115 is 12 mm thick. Small reflection's irregularities on the base are due to manual processing.

Table de repas avec base en acier inox brillant et cylindre en Travertin, marbre noir Marquina ou blanc Carrara. Les plateaux sont en verre clair placés sur la base épaisseur 15mm. Le plateau façonné en 240x115 a une épaisseur de 12mm. Les petites irrégularités de réflexion sur la base sont dues à une fabrication manuelle.

Mesa con base en acero inox brillo. Cilindro en mármol Travertino, negro Marquina o blanco Carrara. Sobre en apoyo en cristal transparente de 15mm. El sobre 240x115 perfilado es 12mm. Pequeñas irregularidad de reflexión en la base están causadas por la producción manual.

Esstisch mit Basis aus glänzendem Edelstahl. Zylinder aus Travertin, schwarzem Marquina oder weißem Carrara Marmor. Platte aus Klarglas auf die Basis gelegt. Glas Stärke 15mm. Die gemodelte Platte 240x115 ist 12mm dick. Kleine Unregelmäßigkeiten der Reflexion auf der Basis sind nicht zu vermeiden, da das Teil per Hand hergestellt wird.

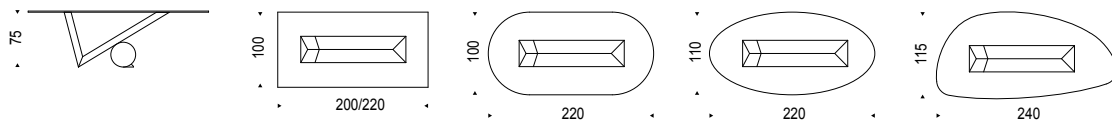







## VIOLA D'AMORE

### Design Piero De Longhi

Tavolo con base in marmo bianco Carrara e cilindro in Travertine, white Carrara or black Marquina marble. Top in 15mm clear glass, laid on the base. Piani in appoggio in cristallo trasparente spessore 15mm. Il piano 240x115 sagomato ha spessore 12mm.

Table with white Carrara marble base and cylinder in Travertine, white Carrara or black Marquina marble. Top in 15mm clear glass, laid on the base. The shaped top 240x115 is 12mm thick.

Table avec base en marbre blanc Carrara et cylindre en Travertin, blanc Carrara ou noir Marquina. Les plateaux sont en verre clair placés sur la base épaisseur 15mm. Le plateau façonné en 240x115 a une épaisseur de 12mm.

Mesa con base en mármol blanco Carrara. Cilindro en mármol Travertino, blanco Carrara o negro Marquina. Sobre en apoyo en cristal transparente de 15mm. El sobre 240x115 perfilado es 12mm.

Tisch mit Basis aus weißem Carrara Marmor. Zylinder aus Travertin, schwarzem Marquina oder weißem Carrara Marmor. Platte aus Klarglas auf die Basis gelegt. Glas Stärke 15mm. Die gemodelte Platte 240x115 ist 12mm dick.

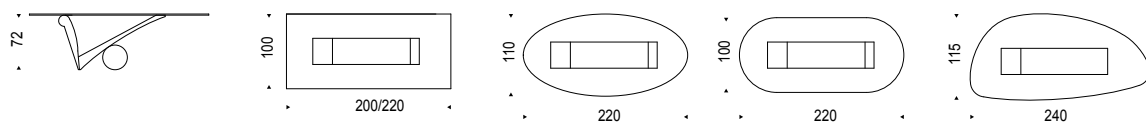







## DIAPASON

### Design Studio Diapason

Consolle con base in Travertino o bianco Carrara e piano in cristallo trasparente 15 mm. Piano in appoggio.

Console with Travertine or white Carrara marble base. Clear glassw 15 mm. The top is laid on the base.

Consolle avec base en Travertin ou blanc Carrara. Plateau en verre clair 15 mm. Plateau en appui.

Consola con base en mármol Travertino o blanco Carrara. Sobre en cristal transparente 15mm. Sobre en apoyo.

Konsole mit Fuß aus Travertin oder weiß Carrara Marmor. Klarglasplatte 15 mm auf dem Basis gelegt.

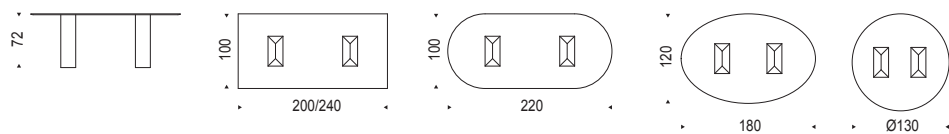







## REEF

Design Piero De Longhi

Tavolo con base in cristalplant bianco opaco. Piano in MDF bianco gofrato fine o bianco Carrara opaco.

Table with matt white cristalplant base. Top in white embossed MDF or matt white Carrara marble.

Table avec base en cristal plant blanc mat. Plateau en MDF gaufré blanc ou blanc Carrara mat.

Mesa con base en cristalplant blanco opaco. Sobre en MDF gofrado blanco o blanco Carrara opaco.

Tisch mit Basis aus Cristalplant matt weiss. Platte in gaufriertem weissem MDF oder matt weiss Carrara Marmor.









## CORAL

Design **Andrea Lucatello**

Tavolo con base in poliuretano verniciato bianco. Piano con piastre in cristallo 15mm trasparente.

Table with white embossed polyurethane base. Top with plates in 15mm clear glass.

Table avec base en polyuréthane verni blanc. Plateau avec plates en verre 15mm clair.

Mesa con base de poliuretano blanco gofrado. Sobre con pletinas en cristal 15mm transparente.

Esstisch mit Basis aus Polyurethan weiß gaufriert lackiert. Platte mit metalplättchen in Klarglas (15mm).

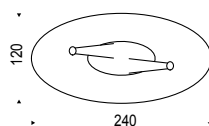
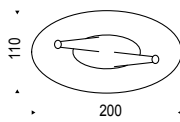
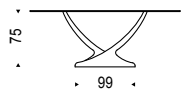





table CORAL - chairs PATRICIA - lamps ZEPPELIN and BOLERO - sideboard NEBRASKA - table lamp MAMBA



## PLISSET

### Design Raffaello Galiotto

Tavolo con base in marmo Palissandro bianco opaco. Piano in cristallo 15mm trasparente o trasparente extrachiaro. I piani 182x90 e 200x106 hanno spessore 12mm. I tavoli con 1 base hanno il piano con le piastre, con 2 basi hanno il piano in appoggio.

Table with base in matt Palissandro white marble. Top in 15mm clear or extra clear glass. Glass top in 12mm on 182x90 and 200x106 versions. Top with plates in 1 base version, top laid on the base in 2 bases version.

Table avec base en marbre Palissandro blanc mat. Plateau en verre clair ou extra-clair 15 mm. Les plateaux 182x92 et 200x106 sont de 12 mm. Pour les tables avec une base, le plateau est avec une plaque et pour les tables avec deux bases le plateau est d'appui.

Mesa con base en mármol Palissandro blanco mate. Sobre en cristal 15mm transparente o transparente extraclaro. Los sobros 182x90cm y 200x106cm son de 12mm. Los sobros con 1 base tienen el sobre con las pletinas, los con 2 bases tienen sobre en apoyo.

Esstisch mit Basis im matt weiß Palissandro Marmor. Platte in 15 mm Glas transparent oder extra hell transparent. Platten in 182x90 und 200x106 sind in 12 mm Dicke. Tische mit einer Basis: die Platte hat die Metallplättchen; Tische mit 2 Basis: die Platte ist auf die Basis gelegt.

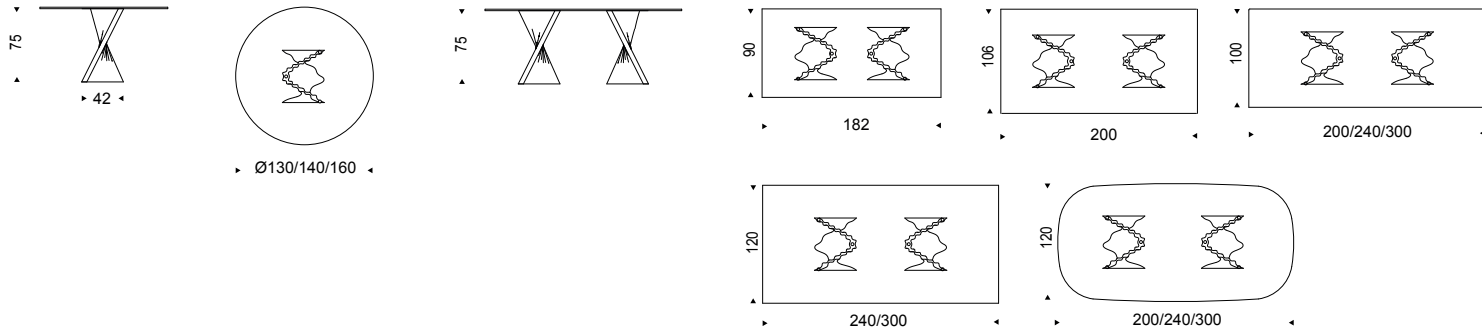









SWANSON & SONS WIDA GOLDSMOLLER ANDY GOLDSWORTHY







**GIANO KERAMIK****Design Manzoni & Tapinassi**

Tavolo con base in acciaio verniciato gofrato bianco, nero o graphite. Piano in ceramica Marmi Calacatta, Alabastro o Ardesia. Opzionale vassoio centrotavola girevole Lazy Susan.

Table with base in white, black or graphite embossed lacquered steel. Marmi Calacatta, Alabastro or Ardesia ceramic top. Opzionale plateau central swivelling tray Lazy Susan.

Table avec base en acier gaufré verni blanc, noir ou graphite. Plateau en céramique Marmi Calacatta, Alabastro ou Ardesia. Opzionale plateau central pivotant Lazy Susan.

Mesa con base en acero barnizado gofrado blanco, negro o graphite. Sobre en cerámica Marmi Calacatta, Alabastro o Ardesia. Opzionale bandeja sobremesa giratoria Lazy Susan.

Esstisch mit Basis in Stahl lackiert weiß, schwarz oder graphit gaufriert. Platte in Keramik Marmi Calacatta, Alabastro oder Ardesia. Opzionale drehbare Tablette Lazy Susan.





















table GIANO marble Carrara - chairs BETTY - lamp OKTOPUS



## SKORPIO ROUND

Design **Andrea Lucatello**

Tavolo con base in acciaio verniciato trasparente, goffrato bianco, nero o graphite. Piano in legno noce Canaletto o rovere bruciato, in cristallo trasparente o trasparente extrachiaro con bordo bisellato 15mm. Opzionale vassoio centrotavola girevole in cristallo extrachiaro acidato verniciato bianco, nero o graphite.

Table with transparent varnished metal base, white, black or graphite embossed lacquered steel. Top in Canaletto walnut or burned oak, in clear or extra clear glass with bevelled 15mm edges. Optional central swivelling tray in white, black or graphite painted extra clear frosted glass.

Table avec base en acier verni transparent, gaufré blanc, noir ou graphite. Plateau en bois noyer Canaletto ou rouvre brûlé, verre clair ou extra-clair avec bord biseauté 15 mm. Optionnel: plateau central pivotant en verre extra-clair acidé verni blanc, noir ou graphite.

Mesa con base en acero barnizado transparente, gofrado blanco, negro o graphite. Sobre en madera nogal Canaletto o roble ahumado, en cristal transparente o transparente extraclaro con borde biselado 15mm. Opcional bandeja centro mesa giratoria en cristal extraclaro translúcido barnizado blanco, negro o graphite.

Esstisch mit Basis aus Metall lackiert transparent, oder weiß, schwarz oder graphit gaufriert. Platte in Nussbaum Canaletto, "verbrannte Eiche", Glas transparent oder Glas extra hell transparent mit Kanten facettiert 15 mm Dicke. Optional drehbare Tablette in Glas extra hell geätzt lackiert weiß, schwarz oder graphit.

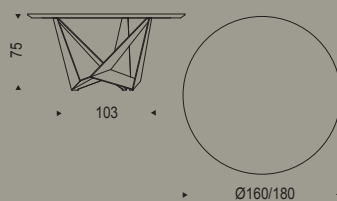
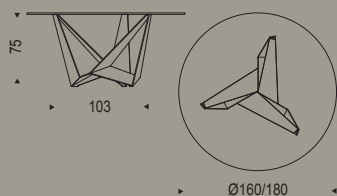
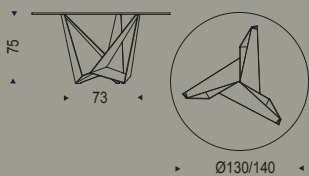

## LAZY SUSAN

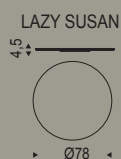
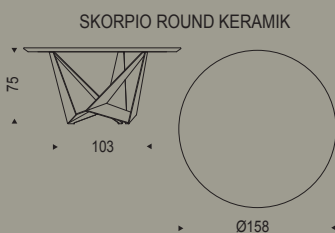
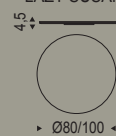

table SKORPIO ROUND - chairs MAGDA B - lamps HUBLLOT







## ELIOT ROUND

### Design Giorgio Cattelan

Tavolo con base in acciaio verniciato goffrato bianco, nero, graphite o inox satinato. Piano in cristallo 15mm extrachiaro acidato verniciato bianco o graphite, in marmo bianco Carrara o Emperador, in noce Canaletto o rovere bruciato. I piani in marmo sono composti da quattro spicchi. Opzionale vassoio centrotavola girevole in cristallo extrachiaro acidato verniciato bianco, nero o graphite o marmo bianco Carrara o Emperador.

Table with base in white, black or graphite embossed lacquered steel or in satin stainless steel. 15mm top in white or graphite painted extra clear frosted glass or white Carrara, Emperador marble, Canaletto walnut or burned oak. Marble tops are composed of four segments. Optional swivelling tray in white, black or graphite painted extra clear frosted glass or white Carrara or Emperador marble.

Table avec base en acier inox mat ou gaufré verni blanc, noir ou graphite. Plateau en verre 15mm extra-clair dépoli verni blanc ou graphite, en marbre blanc Carrara ou Emperador, en noyer Canaletto ou rouvre brûlé. Dessus de marbre sont composés de quatre segments. Optionnel plateau central pivotant en verre extra-clair acide verni blanc, noir ou graphite ou marbre blanc Carrara ou Emperador.

Mesa con base en acero barnizado gofrado blanco, negro o graphite o inox satinado. Sobre en cristal 15mm extrachiaro translúcido barnizado blanco o graphite, en mármol blanco Carrara o Emperador, en nogal Canaletto o roble ahumado. Los sobres de mármol se componen de cuatro segmentos. Opcional bandeja sobremesa giratoria in cristal extraclaro translúcido barnizado blanco, negro o graphite o mármol blanco Carrara o Emperador.

Esstisch mit Basis aus Edelstahl lackiert weiß, schwarz oder graphite oder aus Edelstahl gebürstet. Platte in 15mm Glas extra hell geätzt weiß oder graphite lackiert, aus weiß Carrara oder Emperador Marmor, Nussbaum Canaletto oder "verbrannte Eiche". Die Marmorplatten sind aus vier Segmenten zusammengesetzt. Optional drehbare Tablette in Glas extra hell lackiert geätzt weiß, schwarz oder graphite, weiß Carrara oder Emperador Marmor.

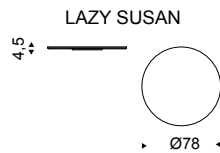
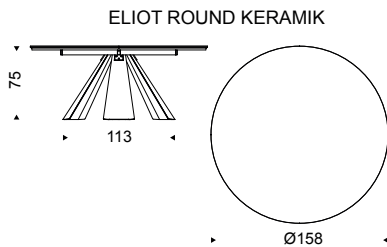
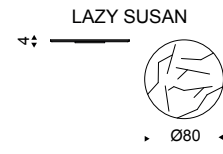
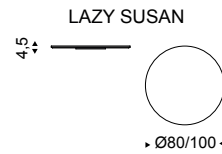
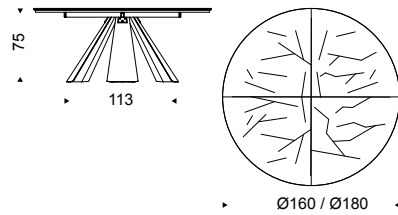
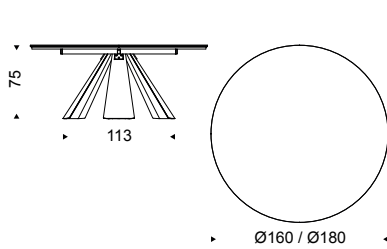













table ELIOT ROUND + lazy susan - chairs LULU' - lamp ZEPPELIN



## RAY

### Design Paolo Cattelan

Tavolo con gambe in acciaio verniciato bianco o graphite opaco, cromato, cromo nero o rivestite in cuoio come da campionario. Piano in cristallo trasparente temperato 15mm.

Table with base in chromed steel, black chrome or painted matt white, matt graphite or covered in leather as per sample card. Top in 15mm tempered clear glass.

Table avec piétement en acier laqué blanc matt, graphite matt, acier chromé ou chrome noir ou cuir selon échantillons. Plateau en verre clair trempé 15mm.

Mesa con patas en acero barnizado blanco o graphite opaco, cromado o cromo negro o revestidas en cuero según muestrario. Sobre en cristal transparente templado 15mm.

Esstisch mit Beine aus Stahl lackiert weiss matt, graphite matt, verchromtem oder schwarz chrom Stahl oder mit Kurllederbezug laut Musterkarte. Platte aus Klarglas 15mm Sicherheit.

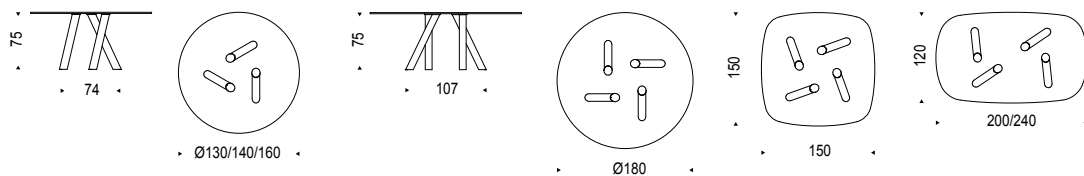







**CORTINA****Design Pierluigi Stella**

Tavolo con base in acciaio inox o noce Canaletto e acciaio inox o rovere bruciato e acciaio inox. Piano con piastre in cristallo trasparente 15mm.

Table with base in stainless steel or Canaletto walnut and stainless steel or burned oak and stainless steel. Top with plates in 15mm clear glass.

Table avec base en acier inox ou noyer Canaletto et acier inox ou rouvre brulé et acier inox. Plateau avec plates en verre transparent 15mm.

Mesa con base en acero inox o madera nogal Canaletto y acero inox o roble ahumado y acero inox. Sobre con pletinas en cristal transparente 15mm.

Tisch mit basis entweder aus Edelstahl oder Nußbaumholz Canaletto und Edelstahl oder "verbrannte Eiche" und Edelstahl. Platte mit metalplättchen aus transparentem Glas 15mm.

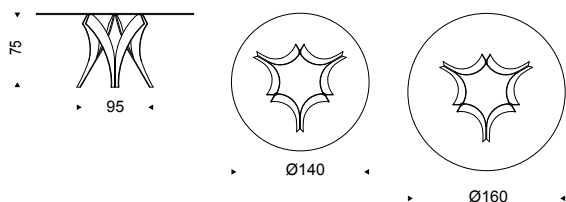



**BORA BORA****Design Giorgio Cattelan**

Tavolo con base in alluminio verniciato gofrato bianco o graphite. Piano in noce Canaletto o graphite. Piano in noce Canaletto o rovere bruciato.

Table with base in white or graphite embossed lacquered aluminium. Top in Canaletto walnut or burned oak.

Table avec base en acier gaufré verni blanc ou graphite. Plateau en noyer Canaletto ou rouvre brûlé.

Mesa con base en aluminio barnizado gofrado blanco o graphite). Sobre en nogal Canaletto o roble ahumado).

Esstisch mit Basis in Aluminium lackiert weiß oder graphit gaufriert. Platte in Nussbaum Canaletto oder "verbrannte Eiche".

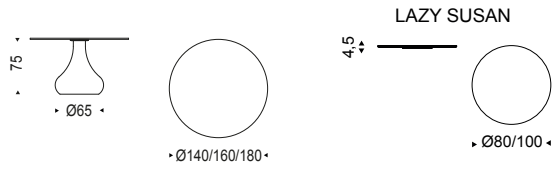

table BORA BORA - chairs TOSCA - lamp VENEZIA - sideboard NEBRASKA - mirror REBUS - table lamp BOLERO - showcase SABA



**PEDRO**

**Design Pierluigi Stella**

Tavolo con base in acciaio verniciato bianco o graphite opaco, con o senza profili in acciaio inox. Piano in postformato laminato bianco opaco, laminato porfido grigio, laminato ossido grigio, laminato olmo bianco.

Table with base in matt white or graphite painted steel with or without profile in stainless steel. Top in postformed, grey porphyry, grey oxide, white elm laminated wood.

Table avec base en acier laqué blanc ou graphite mat, avec ou sans profil en acier inox. Plateau postformé en laminé blanc mat, laminé porphyre gris, laminé ossido gris, laminé orme blanc.

Mesa con base en acero barnizado blanco o graphite opaco, con o sin perfil en acero inox. Sobre en postformado laminado blanco opaco laminado porfido gris, laminado óxido gris, laminado olmo blanco.

Esstisch mit Basis aus Edelstahl lackiert in matt weiß oder matt graphite, mit oder ohne Profilen aus Edelstahl. Platte aus postforming matt weiß laminat, Laminat grau Porphy, Laminat grau Oxid oder Laminat Ulme weiß.

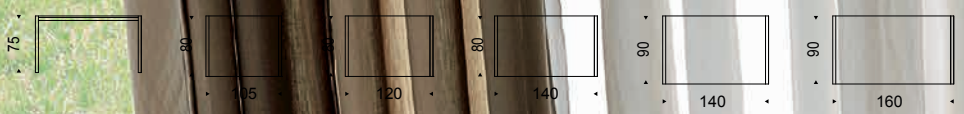

PEDRO DRIVE → EXTENDABLE TABLE pag. 242

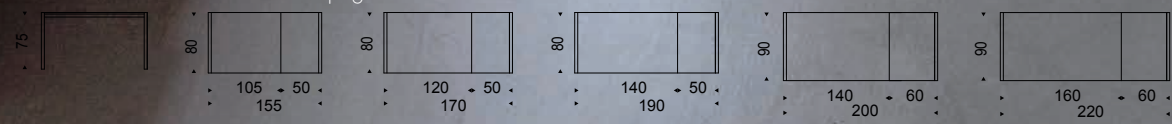









BASE WHITE / TOP WHITE



BASE INOX - WHITE / TOP OLMO



BASE INOX - GRAPHITE / TOP OSSIDO



BASE INOX - GRAPHITE / TOP OLMO





BASE INOX - WHITE / TOP OSSIDO



BASE GRAPHITE / TOP PORFIDO



## ELVIS WOOD

### Design Alberto Danese

Tavolo con base in acciaio inox o verniciato goffrato bianco o graphite. Piano in noce Canaletto, rovere bruciato o rovere naturale.

**Versione "S"** con bordi irregolari in massello in noce Canaletto, rovere bruciato o rovere naturale spessore 4 cm.

**Versione "A"**: piano con bordi obliqui in noce Canaletto, rovere Heritage o rovere naturale, spessore di 4 cm.

Table with base in white or graphite embossed lacquered steel or in stainless steel. Top in Canaletto walnut, burned oak or natural oak.

4 cm thick top **"S" version** with irregular solid wood edges in Canaletto walnut, burned oak or natural oak.

**Version "A"**: top with angled edges in Canaletto walnut, Heritage oak or natural oak. Wooden top 4 cm.

Table avec base en acier verni blanc mat, graphite mat ou inox. Plateau en noyer Canaletto, rovere brulé ou rouvre naturel.

**Version "S"** avec bord irréguliers en bois massif noyer Canaletto, rovere brulé ou rouvre naturel en épaisseur 4 cm.

**Version "A"**: plateau en noyer Canaletto, rovere Heritage ou rouvre naturel avec bords biseauté, épaisseur 4 cm.

Mesa con base en acero inox o barnizado gofrado blanco o graphite. Sobre en nogal Canaletto, roble ahumado o roble natural.

Grosor sobre de 4 cm en la **versión "S"** en nogal Canaletto, roble ahumado o roble natural con bordes irregulares en maciso.

**Versión "A"**: sobre en nogal Canaletto, roble Heritage o roble natural con bordes obliquos, con grosor 4 cm.

Esstisch mit Basis aus Edelstahl, Stahl lackiert weiß oder graphit gaufriert. Platte in Nussbaum Canaletto "verbrannte Eiche" oder Eiche natur.

**Version "S"** mit irregelmessigen Kanten in massives Holzes noce Canaletto oder verbrannte Eiche oder Eiche Natur. Dicke den Platten 4 cm.

**Version "A"**: Platte in Nussbaum Canaletto, Eiche Heritage oder Natur Eiche mit schräge Kanten, 4 cm Dicke.

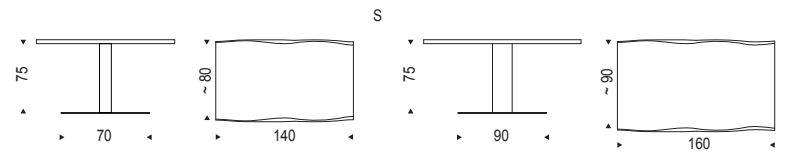
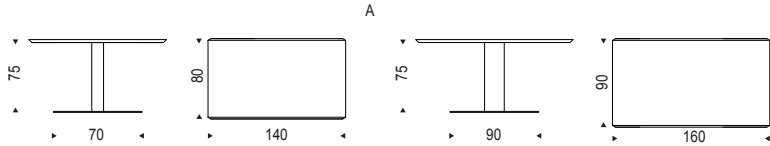

### ELVIS WOOD DRIVE → EXTENDABLE TABLE pag. 182

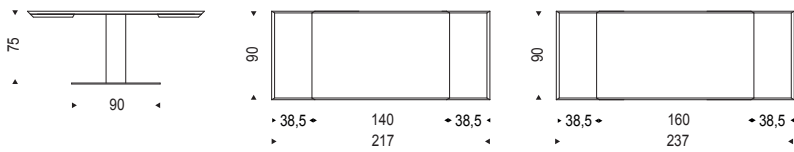





table ELVIS WOOD - S (natural oak) - chairs KAORI - lamp ZEPPELIN



## ELVIS KERAMIK

### Design Alberto Danese

Tavolo con base in acciaio inox o verniciato gofrato bianco o graphite. Piano in ceramica Laminam Fokos nei colori sale o piombo o ceramica Marmi Calacatta, Alabastro o Ardesia.

Table with base in white or graphite embossed lacquered steel or in stainless steel. Laminam Fokos ceramic top in salt or lead colours or in Marmi ceramic Calacatta, Alabastro or Ardesia.

Table avec base en acier laqué gaufré blanc, graphite ou inox brillant. Plateau en céramique Laminam Fokos dans les couleurs sel ou plomb ou céramique Marmi Calacatta, Alabastro ou Ardesia.

Mesa con base en acero inox o barnizado gofrado blanco o graphite. Sobre en cerámica Laminam Fokos colores sal, plomo o cerámica Marmi Calacatta, Alabastro o Ardesia.

Esstisch mit Basis aus Edelstahl oder Stahl lackiert weiß oder graphite gaufriert. Platte in Keramik Laminam Fokos in den Farben Salz oder Blei, oder Keramik Marmi Calacatta, Alabastro oder Ardesia.

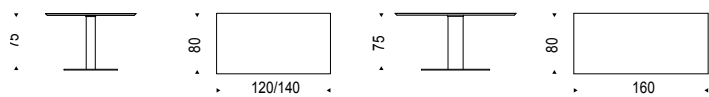

table ELVIS KERAMIK (Calacatta) - chairs PIUMA - lamps DREAM - sideboard LABYRINTH - mirror EXCALIBUR







## ELVIS

### Design Alberto Danese

Tavolo con base in acciaio inox o verniciato goffrato bianco o graphite. Piano in cristallo trasparente 15mm, in laminato grigio Londra Fenix o castoro Ottawa Fenix. Opzionale: prolunghe in acciaio inox solo per piani in cristallo 80 cm.

Table with base in white, graphite embossed lacquered steel or in stainless steel. Top in 15mm clear glass, grey London Fenix or beaver Ottawa Fenix laminated wood. Opzionale: stainless steel extensions only for glass top 80 cm.

Table avec base en acier laqué gaufré blanc, graphite ou inox brillant. Plateau en verre clair 15mm, en laminé gris Londres Fenix ou castor Ottawa Fenix. Optionnels: rallonges en acier seulement pour le plateau en verre 80 cm.

Mesa con base en acero inox o barnizado gofrado blanco o graphite. Sobre en cristal transparente 15mm, laminado gris Londres Fenix o castor Ottawa Fenix. Opcional: extensiones en acero solo por el sobre en cristal 80 cm.

Esstisch mit Basis aus Edelstahl oder Stahl lackiert weiß oder graphite gaufriert. Platte aus Klarglas transparent 15mm, grau Fenix Laminat oder Biber Ottawa Fenix Laminat. Optional: edelstahl Verlängerungen nur für Glasplatte 80 cm.

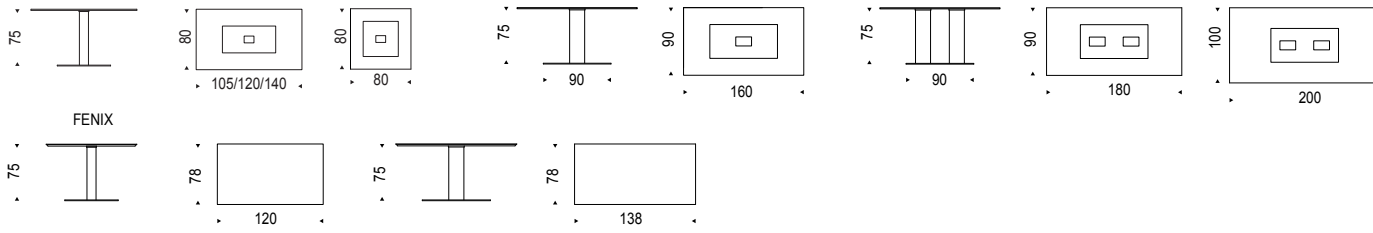

ELVIS DRIVE → EXTENDABLE TABLE pag. 251

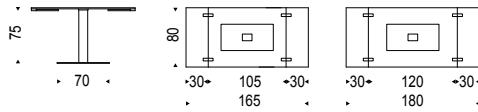

ELVIS WINGS → EXTENDABLE TABLE pag. 250

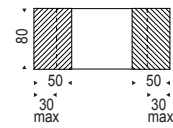

table ELVIS - chairs MULAN - lamps MIDDAY - sideboard DAKOTA - shelves PENDOLA - rug HALIBUT















## OBELISCO

### Design Oriano Favaretto

Tavolo con base in acciaio inox o verniciato gofrato graphite. Gamba in cemento verniciato in pasta nei colori bianco o grigio. Piano con piastra in cristallo trasparente 15mm.

Table with base in stainless steel or graphite embossed lacquered steel. Leg in white or grey colored cement. 15mm clear glass top with plate.

Table avec base en acier inox brillant ou laqué gaufré graphite. Pied en ciment coloré blanc ou gris. Plateau en verre clair 15mm avec plaque.

Mesa con base en acero inox o barnizado gofrado graphite. Pata en cemento pintado blanco o gris. Sobre con placa en cristal transparente 15mm.

Esstisch mit Basis aus Edelstahl oder Stahl lackiert graphite gaufriert. Bein aus Zementleim in den Farben weiß oder grau. Platte mit Metallplättchen in Klarglas 15mm.

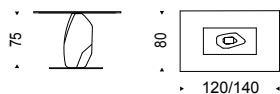















**HUGO BISTROT****Design Philip Jackson**

Tavolo bistrot con base in poliuretano verniciato bianco o nero. Piano in cristallo trasparente 12mm o in MDF laccato bianco o nero opaco.

Bistrot table with white or black embossed polyurethane base. Top in 12mm clear glass or white or black lacquered MDF.

Table bistrot avec base en polyuréthane verni blanc ou noir. Plateau en verre clair 12mm ou en MDF laqué blanc ou noir.

Mesa bistrot con base en poliuretano pintado blanco o negro. Sobre en cristal transparente 12mm o MDF pintado blanco o negro.

Bistrot Tisch mit Basis aus lackiertem Polyurethan in den Farben weiß oder schwarz. Platte aus Klarglas 12mm oder aus lackiertem MDF weiß oder schwarz.

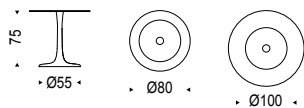



**HENRY****Design Silver Studio**

Tavolo bistrot con base in acciaio inox, colonna in acciaio cromato e piano in cristallo trasparente.

Bistrot table with base in stainless steel and chromed foot and top in clear glass.

Bistrot avec base en acier inox, pied chromé et top en verre clair.

Mesa bistrot con base en acero inox y pata cromada. Sobre en cristal transparente.

Bistrot Tisch mit Bein aus Edelstahl, Fußsteller verchromt. Platte in klarem Glas.

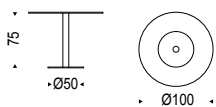



## ROGER

### Design Paolo Cattelan

Tavolo con base in acciaio verniciato trasparente, gofrato bianco o graphite. Piano in legno noce Canaletto, rovere bruciato o in cristallo trasparente temperato 12 mm.

Table with transparent varnished metal base, white or graphite embossed lacquered steel. Top in Canaletto walnut, burned oak or 12 mm tempered clear glass.

Table avec base en acier laqué transparent, gaufré blanc ou graphite. Plateau en bois noyer Canaletto, rouvre brulé ou verre clair trempé 12 mm.

Mesa con base en acero barnizado transparente, gofrado blanco o graphite. Sobre en nogal Canaletto, roble ahumado o en cristal transparente templado 12 mm.

Esstisch mit Basis aus Metall lackiert transparent, weiß oder graphite gaufriert. Platte in Nussbaum Canaletto oder verbrannte Eiche oder transparentem Sicherheitsglas 12 mm.

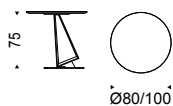
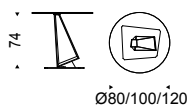







**ROGER KERAMIK**

**Design Paolo Cattelan**

Tavolo con base in acciaio verniciato trasparente, gofrato bianco o graphite. Piano in ceramica Marmi Calacatta, Alabastro o Ardesia.

Table with transparent varnished metal base, white or graphite embossed lacquered steel. Top in Marmi ceramic Calacatta, Alabastro or Ardesia.

Table avec base en acier laqué transparent, gaufré blanc ou graphite. Plateau en céramique Marmi Calacatta, Alabastro ou Ardesia.

Mesa con base en acero barnizado transparente, gofrado blanco o graphite. Sobre en cerámica Marmi Calacatta, Alabastro o Ardesia.

Esstisch mit Basis aus Metall lackiert transparent, weiß oder graphite gaufriert. Platte in Keramik Marmi Calacatta, Alabastro oder Ardesia.

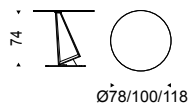

ceramic Alabastro





table ROGER KERAMIK (Alabastro) - chairs NINA - sideboard PRISMA - lamp BOLERO



## BORA BORA BISTROT

### Design Giorgio Cattelan

Tavolo con base in alluminio verniciato gofrato bianco o graphite. Piano in MDF verniciato bianco, graphite opaco o impiallacciato con sezione di tronco d'albero di rovere. Le misure del piano in sezione di rovere sono indicative ed ogni pezzo è unico e diverso nella forma e nella misura.

Table with base in white or graphite embossed lacquered aluminium. MDF veneered top in log section of oak tree trunk or matt white or graphite painted MDF. Approximate sizes of the oak top, each piece is unique and different in shape and size.

Table avec base en acier gaufré verni blanc ou graphite. Plateau en MDF verni blanc mat, graphite mat ou plaqué avec une section de rouvre. Les mesures du top en section de rouvre sont indicatifs et chaque pièce est unique et différent dans la forme et la taille.

Mesa con base en aluminio barnizado gofrado blanco o graphite. Sobre en MDF barnizado blanco mate, graphite mate o contrachapado con sección de roble. Medidas del sobre en sección de roble indicativas, cada pieza es única y distinta en la forma y en las medidas.

Esstisch mit Basis aus Aluminium lackiert weiß gaufriert oder graphit. Platte in MDF weiß lackiert, graphit matt oder furniert mit Heichebaumschnitt. Die angegebenen Massen bei der Version in furniert, sind Indikativ, da jeder Platte ist eine Unikat mit eigener Form und Größe.

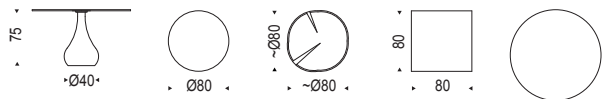











**XOM KERAMIK****Design Paolo Cattelan**

Tavolo con base in acciaio verniciato gofrato bianco, nero o graphite oppure con base in acciaio verniciato gofrato bianco, nero o graphite inserti colonna in acciaio inox lucido e base in acciaio inox satinato. Piano in ceramica Marmi Calacatta, Alabastro o Ardesia.

Table with white, black or graphite embossed lacquered steel base or with white, black or graphite central leg and shiny stainless steel inserts, base in satin stainless steel. Top in Marmi ceramic Calacatta, Alabastro or Ardesia.

Table avec base en acier gaufré blanc, noir ou graphite ou colonne en acier verni gaufré blanc, noir ou graphite avec inserts colonne en acier inox et base en acier inox satiné. Plateau en céramique Marmi Calacatta, Alabastro ou Ardesia.

Mesa con base en acero barnizado gofrado blanco, negro o graphite o con columna central en acero barnizado gofrado blanco, negro o graphite cubierta parcialmente en acero inox lúcido y base en acero inox satinado. Sobre en cerámica Marmi Calacatta, Alabastro o Ardesia.

Esstisch mit Basis aus Metall lackiert weiß, schwarz oder graphite gaufriert oder mit Basis aus Metall lackiert weiß, schwarz oder graphite gaufriert, Spalte Einsätze aus glänzendem Edelstahl und Basis aus satiniertem Edelstahl. Platte in Keramik Marmi Calacatta, Alabastro oder Ardesia.

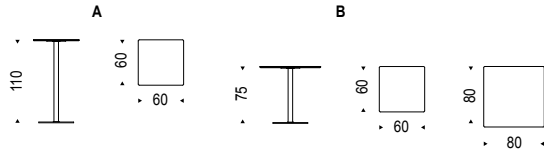



TAVOLI ALLUNGABILI \_EXTENDIBLE TABLES



AZIMUT 218



BRERA 230



DAYTONA 222



DAYTONA ALMOND 226



ELVIS DRIVE 251



ELVIS WINGS 250



ELVIS WOOD DRIVE 238



IKON DRIVE 192



PEDRO DRIVE 242



SIGMA DRIVE 196





ELAN DRIVE

200



ELIOT DRIVE

190



ELIOT KERAMIK DRIVE

186



ELIOT WOOD DRIVE

182



JEREZ DRIVE

206



MONACO DRIVE

198



MONDAY

234



NEMO DRIVE

246



ZEUS DRIVE

212



ZEUS DRIVE KERAMIK

216



## ELIOT WOOD DRIVE

### Design Giorgio Cattelan

Tavolo allungabile con base in acciaio verniciato gofrato bianco, nero, graphite o inox satinato. Piano e prolunghe con bordi obliqui in legno noce Canaletto o rovere bruciato.

Extendible table with base in white, black or graphite embossed lacquered steel or in satin stainless steel. Top and extensions with angled edges in Canaletto walnut or burned oak.

Table à rallonges avec base en acier gaufré verni blanc, noir, graphite ou inox mat. Plateau et rallonges avec bords biseauté en noyer Canaletto ou rouvre brûlé.

Mesa extensible con base en acero barnizado gofrado blanco, negro, graphite o inox satinado. Sobre y extensiones con bordes oblicuos en madera nogal Canaletto o roble ahumado.

Ausziehbarer Esstisch mit Basis in Edelstahl lackiert weiss, schwarz oder graphite gaufriert oder in Edelstahl gebürstet. Platte und Verlängerungen mit schräge Kanten in Nussbaum Canaletto oder "verbrannte Eiche".

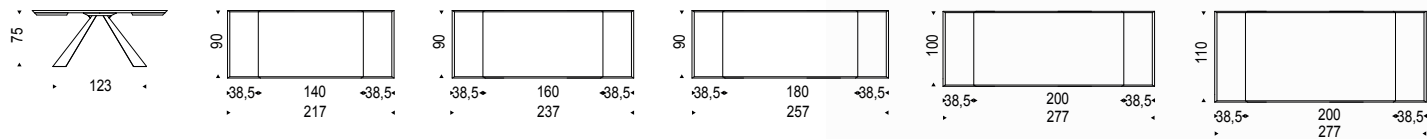

### ELIOT WOOD pag. 76

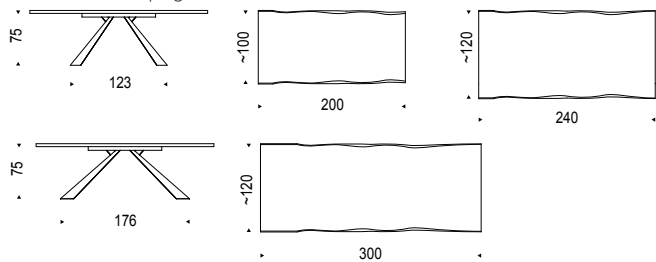















## ELIOT KERAMIK DRIVE

Design **Giorgio Cattelan**

Tavolo allungabile con base in acciaio verniciato gofrato bianco, graphite o inox satinato. Piano e prolunghe in ceramica Laminam Fokos nei colori sale o piombo o ceramica Marmi Calacatta, Alabastro o Ardesia.

Extendible table with base in white or graphite embossed lacquered steel or in satin stainless steel. Laminam Fokos ceramic top and extensions in salt or lead colours or in Marmi ceramic Calacatta, Alabastro or Ardesia.

Table à rallonges avec base en acier laqué gaufré blanc, graphite ou inox satiné. Plateau et rallonges en céramique Laminam Fokos dans les couleurs sel ou plomb ou céramique Marmi Calacatta, Alabastro ou Ardesia.

Mesa extensible con base en acero barnizado gofrado blanco, graphite o inox satinado. Sobre y extensiones en cerámica Laminam Fokos colores sal o plomo o cerámica Marmi Calacatta, Alabastro o Ardesia.

Ausziehbarer Esstisch mit Basis in Edelstahl lackiert weiß, graphite gaufriert oder in Edelstahl gebürstet. Platte und Verlängerungen in Keramik Laminam Fokos in den Farben Salz oder Blei oder Keramik Marmi Calacatta, Alabastro oder Ardesia.

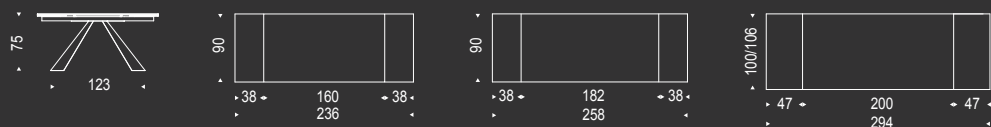

ELIOT KERAMIK pag. 80

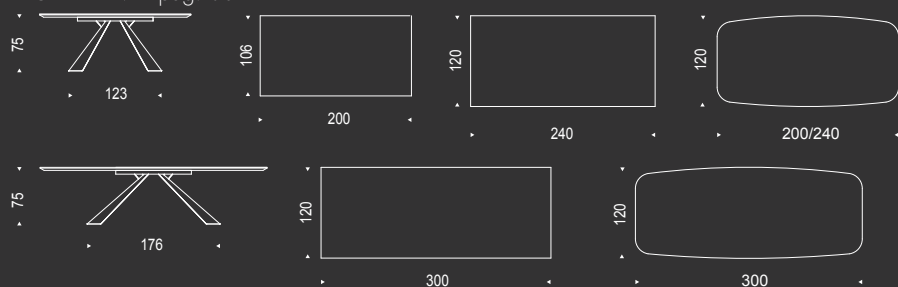

table ELIOT KERAMIK DRIVE (ceramic Calacatta) - chairs ISABEL H - lamps BOLERO and ZEPPELIN















## ELIOT DRIVE

Design **Giorgio Cattelan**

Tavolo allungabile con base in acciaio verniciato gofrato bianco, graphite o inox satinato. Piano e prolunghe in cristallo 12mm extrachiaro verniciato bianco o graphite o extrachiaro acidato bianco o graphite. Piano in appoggio.

Extendible table with base in white, graphite embossed lacquered steel or in satin stainless steel. Top and extensions in 12mm in white or graphite painted extra clear glass or white or graphite painted frosted extra clear glass.

Table à rallonges avec base en acier gaufré verni blanc, graphite ou inox mat. Plateau et rallonges en verre 12mm extra-clair verni blanc ou graphite ou extra-clair dépoli verni blanc ou graphite. Plateau en appui.

Mesa extensible con base en acero barnizado gofrado blanco, graphite o inox satinado. Sobre y extensiones en cristal 12mm extraclaro barnizado blanco o graphite o extraclaro translúcido barnizado blanco o graphite. Sobre en apoyo.

Ausziehbarer Esstisch mit Basis in Edelstahl lackiert weiss, graphite gaufriert oder in Edelstahl gebürstet. Platte und Verlängerungen in Glas extra hell weiss oder graphite lackiert, oder in Glas extra hell geätzt und weiss oder graphite lackiert. Die Platte in 12mm ist auf die Basis gelegt.

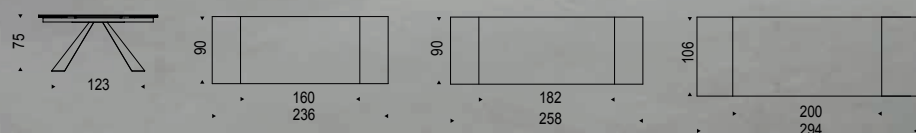





ELIOT pag. 84

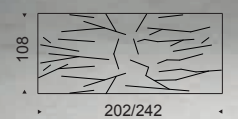
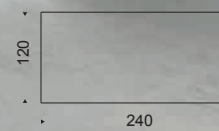
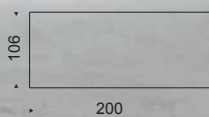
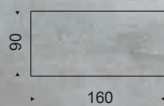
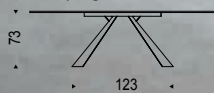



## IKON DRIVE

Design Philip Jackson

Tavolo allungabile con base in cristallo temperato extrachiaro trasparente 15mm e trave in graphite. Piano e prolunghe in noce Canaletto, rovere bruciato o rovere naturale con bordi irregolari in massello. Disponibile anche trave in noce Canaletto, rovere bruciato o rovere naturale.

Extendible table with 15mm extra clear tempered glass base and graphite beam. Top and extensions in solid Canaletto walnut, burned oak or natural oak with irregular solid wood edges. Available also Canaletto walnut, burned oak or natural oak beam.

Table à rallonges, piètement en verre trempé extra-clair transparent 15mm et traverse en graphite. Plateau et rallonges en noyer Canaletto, rovere brulé ou rovere naturel. Bords irréguliers en bois massif. Traverse disponible aussi en noyer Canaletto, rovere brulé ou rovere naturel.

Mesa extensible con base en cristal templado extraclaro transparente 15mm y viga en graphite. Sobre y extensibles en nogal Canaletto, roble ahumado o roble natural con bordes irregulares en macizo. Disponible también viga en nogal Canaletto, roble ahumado o roble natural.

Ausziehbarer Esstisch mit Basis aus 15mm extra hell transparentem gehärtetem Glas und Holm aus graphite. Platte und Verlängerungen aus Nussbaum Canaletto, "verbrannte Eiche" oder Natur Eiche mit massiven Kanten. Holm aus Nussbaum Canaletto, "verbrannte Eiche" oder Natur Eiche verfügbar.

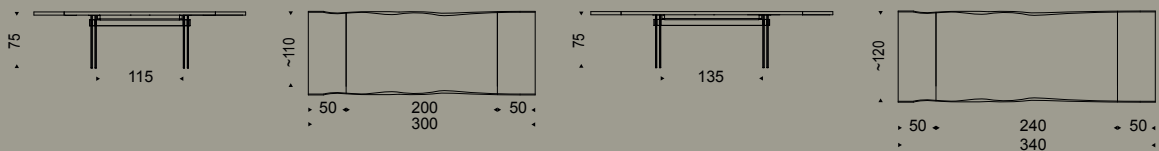

IKON pag. 66

















## SIGMA DRIVE

### Design Philip Jackson

Tavolo allungabile con base in metallo verniciato trasparente. Piano e prolunghe in noce Canaletto, rovere bruciato o rovere naturale con bordi irregolari in massello.

Extendible table with transparent varnished metal base. Top and extensions in Canaletto walnut, burned oak or natural oak with solid irregular edges.

Table à rallonges avec base en métal verni transparent. Plateau et rallonges en noyer Canaletto, rouvre brûlé ou rouvre naturel, bords irréguliers.

Mesa extensible con base en metal barnizado transparente. Sobre y extensibles en nogal Canaletto, roble ahumado o roble natural con bordes irregulares en macizo.

Ausziehbarer Tisch mit Basis aus Metall lackiert transparent. Platte und Verlängerungen aus Nussbaum Canaletto, "verbrannte Eiche" oder Natur Eiche mit massiven Kanten.

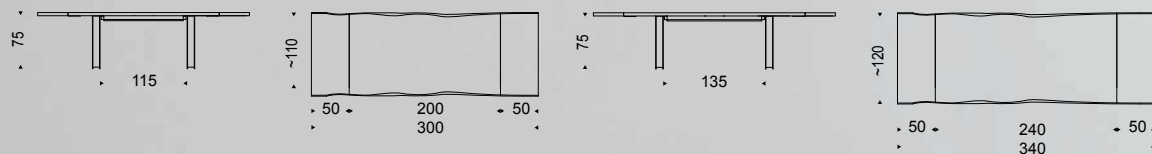

SIGMA pag. 88

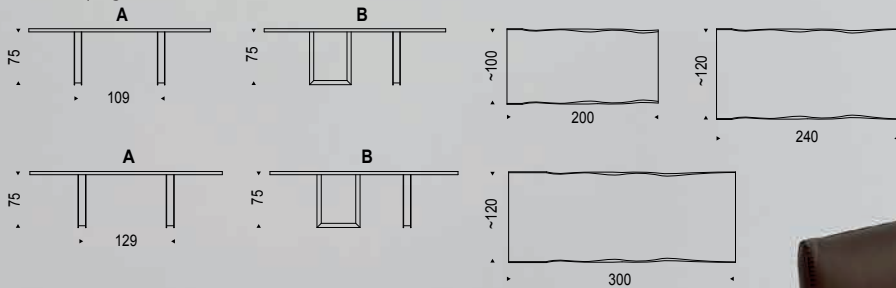







## MONACO DRIVE

Design **Giorgio Cattelan**

Tavolo allungabile con base, piano e prolunghe in noce Canaletto, rovere bruciato. Piedi in acciaio inox lucido.

Extendible table with base, top and extensions in Canaletto walnut, burned oak. Feet in polished stainless steel.

Table à rallonges avec base, plateau et rallonges en noyer Canaletto, rovere brulé. Pieds en acier inox brillant.

Mesa extensible con base, sobre y extensiones en nogal Canaletto, roble ahumado. Patas en acero inox brillo.

Ausziehbarer Esstisch mit Basis, Platte und Verlängerungen aus Nussbaum Canaletto, "verbrannte Eiche". Füße aus glänzendem Edelstahl.

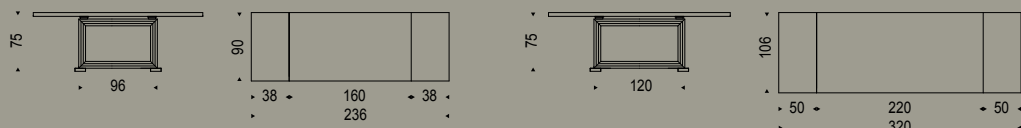

MONACO pag. 92

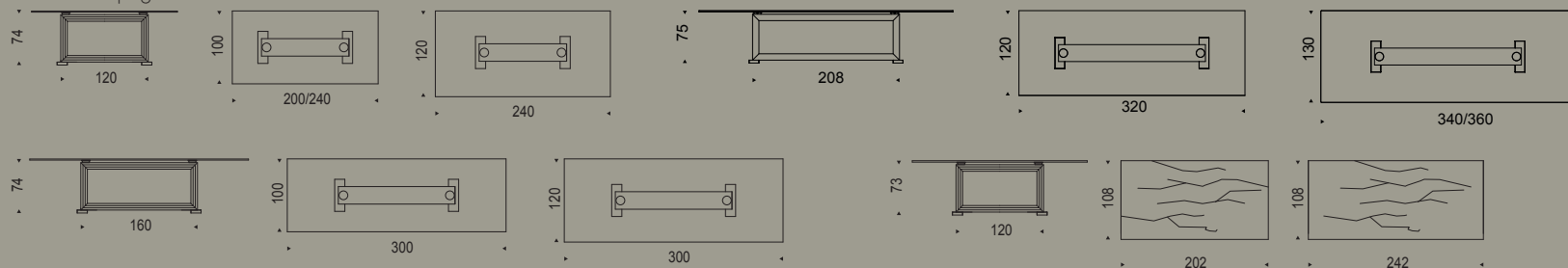

table MONACO DRIVE - chairs BRIGITTA - lamp VENEZIA







## ELAN DRIVE

### Design Paolo Cattelan

Tavolo allungabile con gambe in acciaio inox lucido o satinato o verniciato goffrato graphite o bianco. Binari in alluminio verniciato goffrato bianco o graphite o rivestiti in acciaio inox lucido o satinato con particolari verniciato goffrato graphite, bianco o nero. Piani e prolunghe in cristallo 12mm trasparente o trasparente extrachiaro. Piano in appoggio.

Extendible table with legs in shiny or satin stainless steel, graphite or white embossed lacquered steel. White or graphite embossed lacquered aluminum rails or in shiny or satin stainless steel with graphite, white or black embossed lacquered details. 12mm clear or extra clear glass top and extensions. The top is laid on the base.

Table à rallonges avec pieds en acier inox brillant ou satiné ou gaufré verni graphite ou blanc. Mécanisme en aluminium gaufré verni blanc ou graphite ou en acier inox brillant ou satiné avec détails gaufrés verni graphite, blanc ou noir. Top et rallonges en verre 12mm clair ou transparent extra-clair. Plateau d'appui.

Mesa extensible con patas en acero brillo o mate o en acero barnizado gofrado graphite o blanco. Mecanismo en aluminio barnizado gofrado blanco o graphite o en acero brillo o mate con detalles en barnizado gofrado graphite, blanco o negro. Sobre y extensiones en cristal 12mm transparente o transparente extraclaro. Sobre en apoyo.

Ausziehbarer Esstisch mit Beine aus Edelstahl glänzend oder satiniert oder aus Stahl lackiert gaufriert Graphit oder weiß. Schienen aus Aluminium lackiert gaufriert weiß oder Graphit oder in Edelstahl glänzend oder satiniert mit Einsätze lackiert gaufriert Graphit, weiß oder Schwarz. Platte und Verlängerungen in 12 mm Glass transparent oder extra hell transparent. Platte auf dem Basis gelegt.

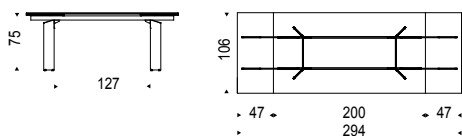
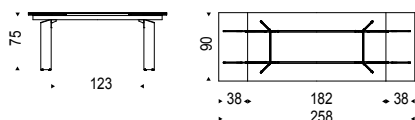
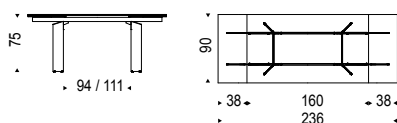







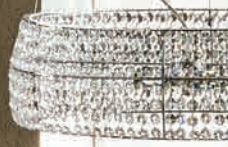





table ELAN DRIVE - chairs ANNA - lamps KIDAL - wall lamp VENEZIA - sideboard KAYAK - mirror EMERALD











## JEREZ DRIVE

### Design Alberto Danese

Tavolo allungabile con base in acciaio e binari in alluminio verniciati gofrato bianco, nero o graphite. Trave centrale in massello naturale di noce Canaletto o acciaio verniciato gofrato bianco, nero o graphite. Piano e prolunghe in cristallo 12mm trasparente o trasparente extrachiaro. Piano in appoggio.

Extendible table with steel base and aluminium rails in white, black or graphite embossed lacquered. Central beam in natural solid Canaletto walnut or embossed white, black, graphite lacquered steel. Top and extensions in 12mm clear or extra clear glass. The top is laid on the base.

Table à rallonges avec base en acier et rails en aluminium gaufré verni blanc, noir ou graphite. Poutre centrale en bois de noyer Canaletto massif ou en acier gaufré verni blanc, noir ou graphite. Plateau et rallonges en verre transparent ou extra-clair transparent 12mm. Plateau en appui.

Mesa extensible con base en acero y mecanismo en aluminio barnizado gofrado blanco, negro o graphite. Viga central en macizo natural de nogal Canaletto o acero barnizado gofrado blanco, negro o graphite. Sobre y extensibles en cristal 12mm transparente o transparente extraclaro. Sobre en apoyo.

Ausziehbarer Esstisch mit Basis aus Edelstahl und Schienen aus Aluminium lackiert weiss, schwarz oder graphite gaufriert. Holm aus massivem natur Nussbaum Canaletto oder gaufriertem Stahl weiss, schwarz oder graphite. Platte und Verlängerungen aus transparentem Glas oder Glas extra hell. Die Platte in 1,5mm ist auf die Basis gelegt.

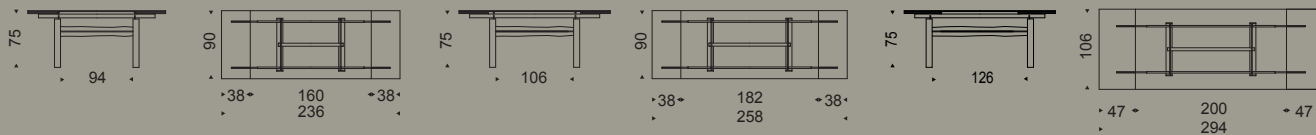

JEREZ pag. 110

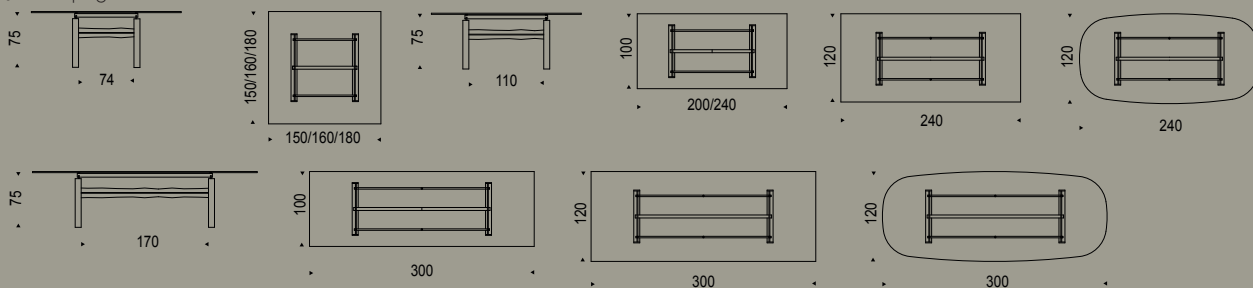





















table JEREZ DRIVE - chairs ALESSIA - lamps GALAXY - mirror WISH BOARD



## ZEUS DRIVE

### Design Gilmo Crosara

Tavolo allungabile con base e binario in acciaio verniciato gofrato bianco, graphite o nero. Piano e prolunghe in cristallo temperato 12mm trasparente, trasparente extrachiaro o fumè.

Extendible table with base and rail in white, graphite or black embossed lacquered steel. Top and extensions in 12mm clear, extra clear or fumè tempered glass.

Table à rallonges avec base et rail en acier laqué gaufré blanc, graphite ou noir. Plateau et rallonges en verre clair, extra-clair ou fumé trempé 12mm.

Mesa extensible con base y mecanismo en acero barnizado gofrado blanco, graphite o negro. Sobre y extensibles en cristal templado 12mm transparente, transparente extraclaro o fumè.

Ausziehbarer Esstisch mit Basis und Schiene aus Edelstahl lackiert weiß, graphite oder schwarz gaufriert. Platte und Verlängerungen in Sicherheit 12 mm Glas transparent, extra hell transparent oder fumé.

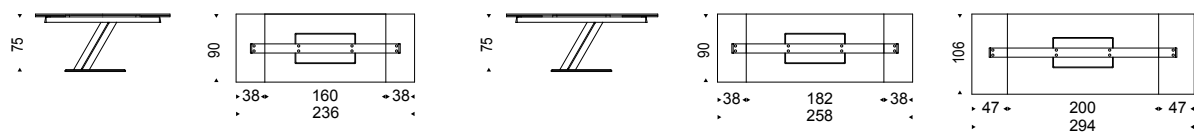















## ZEUS KERAMIK DRIVE

Design **Gilmo Crosara**

avolo allungabile con base e binario in acciaio verniciato gofrato bianco, graphite o nero. Piano e prolunghe in ceramica Laminam Fokos nei colori sale o piombo o ceramica Marmi Calacatta, Alabastro o Ardesia.

Extendible table with base and rail in white, graphite or black embossed lacquered steel. Top and extensions in Laminam Fokos ceramic in salt or lead colours or in Marmi ceramic Calacatta, Alabastro or Ardesia.

Table à rallonges avec base et rail en acier laqué gaufré blanc, graphite ou noir. Plateau et rallonges en céramique Laminam Fokos dans les couleurs sel ou plomb ou céramique Marmi Calacatta, Alabastro ou Ardesia.

Mesa extensible con base y mecanismo en acero barnizado gofrado blanco, graphite o negro. Sobre y extensiones en cerámica Laminam Fokos colores sal o plomo o cerámica Marmi Calacatta, Alabastro o Ardesia.

Ausziehbarer Esstisch mit Basis und Schiene aus Edelstahl lackiert weiß, graphite oder schwarz gaufriert. Platte und Verlängerungen in Keramik Laminam Fokos in den Farben Salz, Blei oder Keramik Marmi Calacatta, Alabastro oder Ardesia.

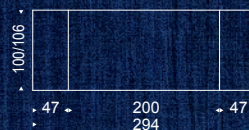
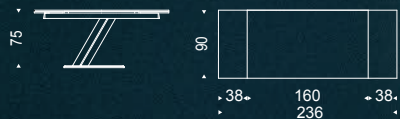







## AZIMUT

### Design Studio Kronos

Tavolo allungabile con gambe in cristallo curvato trasparente o trasparente extrachiaro. Piano e prolunghe in cristallo trasparente o trasparente extrachiaro temperato 15mm (prolunghe 12mm). Meccanismo in acciaio inox lucido e alluminio.

Extendible table with clear or extra clear curved glass legs. Top and extensions in 15mm tempered clear or extra clear glass (extensions 12mm). Mechanism in stainless steel and aluminium.

Table à rallonges avec pieds en verre clair ou extra-clair courbé. Plateau et rallonges en verre transparent ou extra-clair trempé 15mm (rallonges 12mm). Mécanisme de extension en acier inox et aluminium.

Mesa extensible con patas en cristal transparente o transparente extraclaro curvado. Sobre y extensiones en cristal transparente o transparente extraclaro templado 15mm (extensiones 12mm). Mecanismo en acero cromo y aluminio.

Ausziehbarer Esstisch mit gebogenen Füßen aus Klarglas oder extra hell Glas. Platte und Verlängerungen aus klarem oder extra hell Glas Sicherheit 15mm (Verlängerungen 12mm). Verlängerbares Gestell aus Edelstahl und Aluminium.

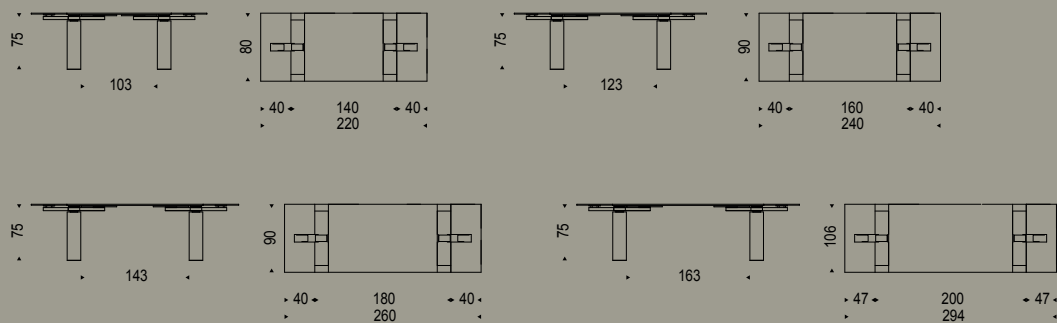















## DAYTONA

### Design Studio Kronos

Tavolo allungabile con gambe in acciaio inox o noce Canaletto. Piano e prolungher in cristallo temperato trasparente o extrachiaro trasparente (piano 15mm, prolungher 12mm). Meccanismo in acciaio inox.

Extendible table with legs in stainless steel or Canaletto walnut. Top and extensions in tempered clear glass or extra clear glass (top 15mm, extensions 12mm). Stainless steel mechanism.

Table à rallonges. Piètement en acier inox ou noyer Canaletto. Plateau et allonges en verre trempé transparent ou transparent extra-clair (plateau 15mm, allonges 12mm). Mécanisme en acier inox.

Mesa extensible con patas en acero inox o nogal Canaletto, sobre y extensiones en cristal templado transparente o extraclaro (sobre 15mm, extensiones 12mm). Mecanismo en acero inox.

Ausziehbarer Esstisch mit Beine aus Edelstahl oder Nußbaum Canaletto. Platte und Verlängerungen aus transparentem oder extra hell transparentem Sicherheitsglas (Platte 15mm, Verlängerungen 12mm). Mechanismus aus Edelstahl.

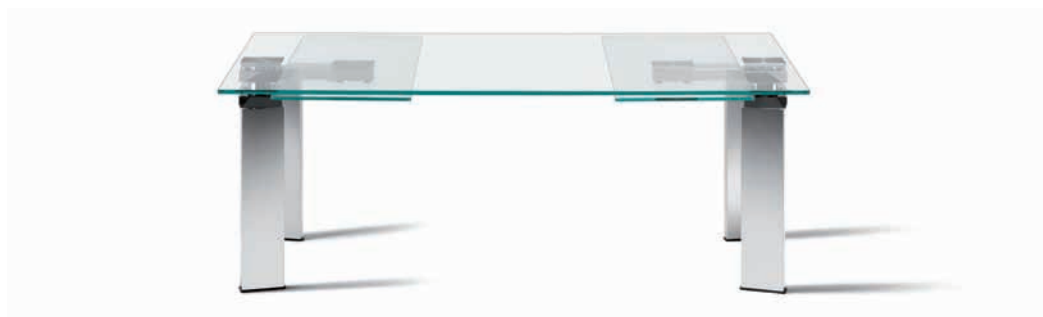
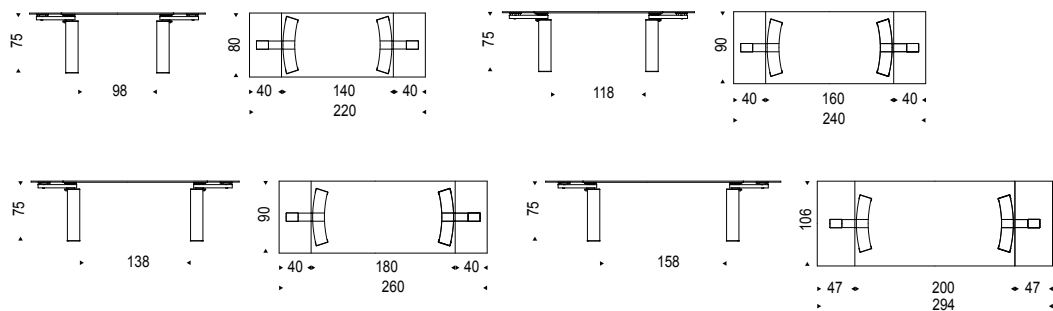















## DAYTONA ALMOND

Design Studio Kronos

Tavolo allungabile con gambe in acciaio inox o noce Canaletto. Piano e prolunghe in cristallo temperato trasparente o extrachiaro trasparente (piano 15mm, prolunghe 12mm). Meccanismo in acciaio inox.

Extendible table with legs in stainless steel or Canaletto walnut. Top and extensions in tempered clear glass or extra clear glass (top 15mm, extensions 12mm). Stainless steel mechanism.

Table à rallonges. Piètement en acier inox ou noyer Canaletto. Plateau et allonges en verre trempé transparent ou transparent extra-clair (plateau 15mm, allonges 12mm). Mécanisme en acier inox.

Mesa extensible con patas en acero inox o nogal Canaletto, sobre y extensiones en cristal templado transparente o extraclaro (sobre 15mm, extensiones 12mm). Mecanismo en acero inox.

Ausziehbarer Esstisch mit Beine aus Edelstahl oder Nußbaum Canaletto. Platte und Verlängerungen aus transparentem oder extra hell transparentem Sicherheitsglas (Platte 15mm, Verlängerungen 12mm). Mechanismus aus Edelstahl.

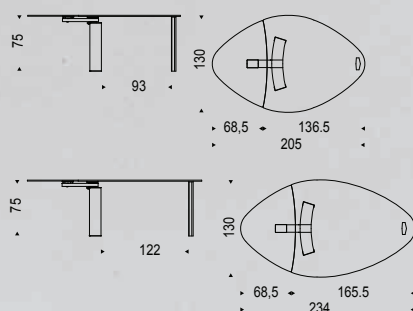















## BRERA

### Design Andrea Gulisano

Tavolo allungabile con gambe in acciaio inox, acciaio verniciato bianco lucido o graphite opaco. Piano in appoggio in cristallo 10mm temperato extrachiaro verniciato bianco o graphite. Prolunga in cristallo 10mm temperato in tinta col piano.

Extendible table with base in stainless steel, varnished polished white or matt graphite steel. Top in 10mm extra clear white varnished tempered glass or extra clear graphite varnished glass. The top is laid on the base. Extension in 10mm tempered glass in the same colour of the top.

Table à rallonges, piètement en acier inox, acier verni blanc brillant ou graphite mat. Plateau d'appui en verre 10mm trempé extra-clair verni blanc ou extra-clair verni graphite. Rallonge en verre 10mm trempé même finissage du plateau.

Mesa extensible con patas en acero inox, acero barnizado blanco brillo o graphite mate. Sobre en apoyo en cristal 10mm templado extraclaro pintado blanco o extraclaro pintado graphite.

Ausziehbarer Esstisch, Beine Edelstahl, Edelstahl lackiert weiß oder matt graphite. Gelegte Platte gehärtetem Glas 10mm lackiert weiß oder graphite. Verlängerung 10mm Glas, Ausführung wie Hauptplatte.

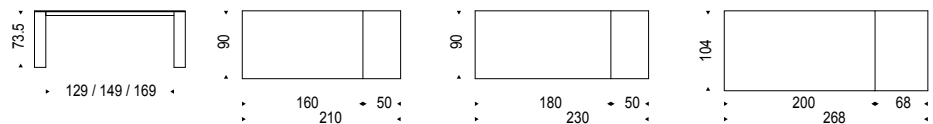















## MONDAY

### Design Pierluigi Stella

Tavolo allungabile con telaio e gambe in acciaio verniciato bianco o graphite opaco. Piano e prolunghe in laminato postformato bianco lucido o piano in cristallo temperato 10mm extrachiaro verniciato bianco con prolunghe in laminato o piano in cristallo extrachiaro verniciato graphite con prolunghe in MDF formicato in tinta.

Extendible table with frame and base in white or graphite varnished steel. Top and extensions in polished white post-formed laminated finish or in tempered extra clear white varnished 10mm glass with extensions in laminated finish, or in extra clear graphite varnished glass with matching formica MDF extensions.

Table à allonges avec pieds et structure en acier verni blanc ou graphite opaque. Plateau et allonges en laminé postformé blanc brillant ou plateau en verre 10mm trempé extra-clair verni blanc avec allonges en laminé, ou plateau en verre extra-clair verni graphite et allonges en MDF de formica en correspondance.

Mesa extensible con estructura y patas en acero barnizado blanco o graphite mate. Sobre y extensiones en laminado postformado blanco brillo o en cristal templado 10mm extraclaro barnizado blanco con extensiones en laminado, o sobre en cristal extraclaro barnizado graphite con extensiones en MDF de formica en juego.

Ausziehbarer Tisch mit Gestell und FüÙe aus Stahl weiss oder graphite matt lackiert. Platte und Verlängerungen aus weiß glänzendem Postforming Laminat oder aus gehärtetem 10mm Optiwhite-Glas weiß lackiert und Verlängerungen aus Laminat, oder Platte aus graphite lackiert und Verlängerungen aus Formica MDF in Farbton.















table MONDAY - chairs ANNA - lamps HUBLOT - mirror EXCALIBUR - rugs HALBUT



## ELVIS WOOD DRIVE

### Design Alberto Danese

Tavolo allungabile con base in acciaio inox o verniciato goffrato bianco o graphite. Piano e prolunghe in legno noce Canaletto o rovere bruciato.

Extendible table with base in white or graphite embossed lacquered steel or in stainless steel. Top and extensions in Canaletto walnut or burned oak.

Table à rallonges avec base en acier gaufré verni blanc, graphite ou inox. Plateau et rallonges en noyer Canaletto ou rouvre brûlé.

Mesa extensible con base en acero inox o barnizado gofrado blanco o graphite. Sobre y extensiones en madera nogal Canaletto o roble ahumado.

Ausziehbarer Esstisch mit Basis aus Edelstahl oder Stahl lackiert weiß oder graphit gaufriert. Platte und Verlängerungen in Nussbaum Canaletto oder "verbrannte Eiche".

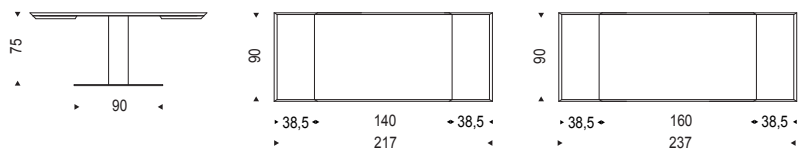

ELVIS WOOD pag. 158

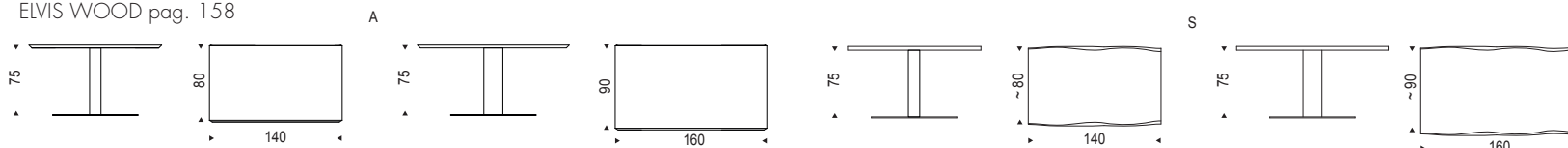















## PEDRO DRIVE

### Design Pierluigi Stella

Tavolo con base in acciaio verniciato bianco o graphite opaco, con o senza profili in acciaio inox. Piano e prolunghe in postformato laminato bianco opaco, laminato porfido grigio, laminato ossido grigio, laminato olmo bianco.

Table with base in matt white or graphite painted steel with or without profile in stainless steel. Top in matt white postformed, grey porphyry, grey oxide, white elm laminated wood.

Table avec base en acier laqué blanc ou graphite mat, avec ou sans profil en acier inox. Plateau postformés en laminé blanc mat, laminé porfido gris, laminé ossido gris, laminé orme blanc.

Mesa con base en acero barnizado blanco o graphite opaco, con o sin perfil en acero inox. Sobre en postformado laminado blanco opaco, laminado pórfido gris, laminado óxido gris, laminado olmo blanco.

Eßtisch mit Basis aus Edelstahl lackiert in matt weiß oder matt graphite, mit oder ohne Profilen aus Edelstahl. Platte aus postforming matt weiß Laminat, Laminat grau Porphyry, Laminat grau Oxid oder Laminat Ulme weiß.

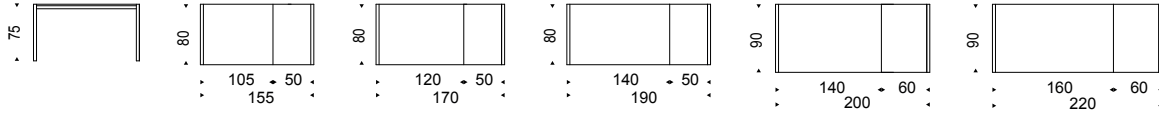

PEDRO pag. 154

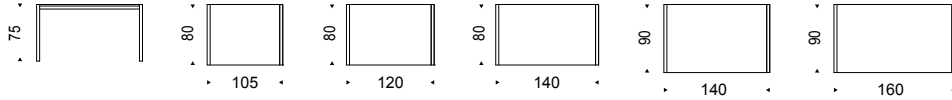











PEDRO DRIVE



table PEDRO - chairs PIUMA, MARGOT - lamps MIDDAY - sideboard NEBRASKA



## NEMO DRIVE

### Design Paolo Cattelan

Tavolo allargabile con base in acciaio verniciato gofrato bianco o graphite. Piano e prolunghe in laminato bianco climb, ossido grigio, noce, grigio Londra Fenix o castoro Ottawa Fenix. Inclusa borsa porta prolunghe.

Extendible table with base in white or graphite embossed lacquered steel. Top and extensions in white climb, grey oxide, walnut, grey London Fenix or beaver Ottawa Fenix laminated wood. Bag for extension included.

Table à rallonges avec base en acier laqué gaufré blanc ou graphite. Plateau et rallonges en laminé blanc climb, oxyde gris, noyer, gris Londres Fenix ou castor Ottawa Fenix. Porte rallonges inclus.

Mesa extensible con base en acero barnizado gofrado blanco o graphite. Sobre y extensiones en laminado blanco climb, óxido gris, nogal, gris Londres Fenix o castor Ottawa Fenix. Bolsa para extensiones incluida.

Ausziehbarer Esstisch mit Basis in Stahl lackiert weiß oder graphite gaufriert. Platte und Verlängerungen aus Laminat weiß Climb, grau Oxid, Nussbaum, London grau Fenix Laminat oder Biber Ottawa Fenix Laminat. Tasche für Verlängerungen ist enthalten.

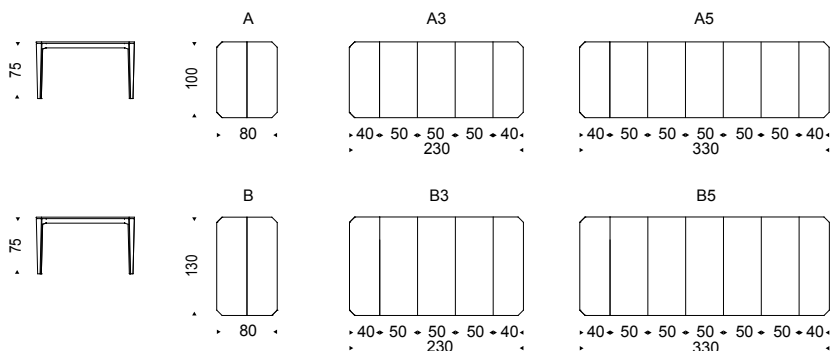















**ELVIS WINGS****Design Alberto Danese**

Tavolo con base in acciaio inox. Piano in cristallo trasparente 15mm. Opzionale: prolunghe in acciaio inox solo per piani in cristallo.

Table with base in stainless steel. Top in 15mm clear glass. Optional: stainless steel extensions only for glass top.

Table avec base en inox brillant. Plateau en verre clair 15mm. Optionnels: rallonges en acier seulement pour le plateau en verre.

Mesa con base en acero inox. Sobre en cristal transparente 15mm. Opcional: extensiones en acero solo par el sobre en cristal.

Esstisch mit Basis aus Edelstahl. Platte aus Klarglas transparent 15mm. Optional: edelstahl Verlängerungen nur für Glasplatte.

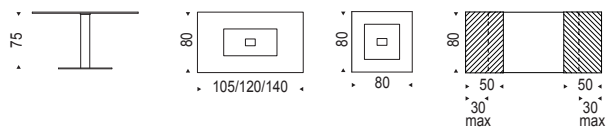



**ELVIS DRIVE****Design Alberto Danese**

Tavolo allungabile con base in acciaio inox anti-impronta e colonna in acciaio inox. Piano in cristallo trasparente temperato 15mm e prolunghe in metacrilato trasparente.

Extendible table with stainless steel anti-marks base and stainless steel column. Top in 15mm clear tempered glass with transparent methacrylate extensions.

Table à rallonges avec pieds en acier inox anti-empainte et colonne en acier inox. Top en verre transparent trempé 15mm et rallonges en méthacrylate transparent.

Mesa extensible con base en acero inox antihuella y columna en acero inox. Sobre en cristal transparente templado 15mm y extensiones en metacrilato transparente.

Ausziehbarer Esstisch mit Basis aus "gegen Abdrücke" Edelstahl und Säule aus Edelstahl. Platte aus Sicherheitsglas transparent 15mm und Verlängerungen aus transparentem Methacrylat.

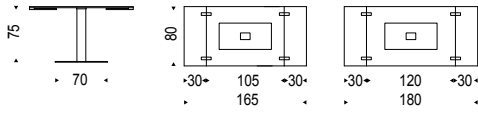



CONSOLLE\_CONSOLES



DIAPASON CONSOLLE 278



ELVIS CONSOLLE 279



HORIZON 280



MONACO CONSOLLE 268



TOUR 264



VALENTINO CONSOLLE 262



VALENTINOX CONSOLLE 260





MONACO CONSOLLE 270



MUSEUM CONSOLLE 276



PORTOFINO 274



RAPA NUI 272



WESTIN 255



WESTIN WOOD 254



WISH BOARD 282







**WESTIN****Design Giorgio Cattelan**

Consolle con base in acciaio verniciato gofrato bianco, graphite o mix. Piano in cristallo 12mm trasparente, trasparente extrachiaro o in legno noce Canaletto, rovere bruciato o rovere naturale con bordo irregolare in massello. Fissaggio a parete necessario.

Console with base in white, graphite or mix embossed lacquered steel. 12mm top in clear, extra clear glass or solid Canaletto walnut, burned oak or natural oak with irregular edges. Wall anchorage is required.

Console avec base en acier gaufré, verni blanc, graphite ou mix. Top en verre transparent, transparent extra-clair 12mm ou en bois de noyer Canaletto, roivre brûlé ou roivre naturel avec bord irrégulier en massif. Fixation au mur est nécessaire.

Consola con base en acero barnizado gofrado blanco, graphite o mix. Sobre en cristal 12mm transparente, transparente extraclaro o de madera nogal Canaletto, roble ahumado o roble natural con bordes irregulares en macizo. Ajuste a la pared es necesario.

Konsole mit Basis in Stahl lackiert weiss oder graphite gaufriert oder mix. Platte in transparentem oder extra hell Glas in 12mm oder aus Holz Nussbaum Canaletto, "verbrannte Eiche" oder Natur Eiche mit massiven Kanten. Wandbefestigung ist notwendig.

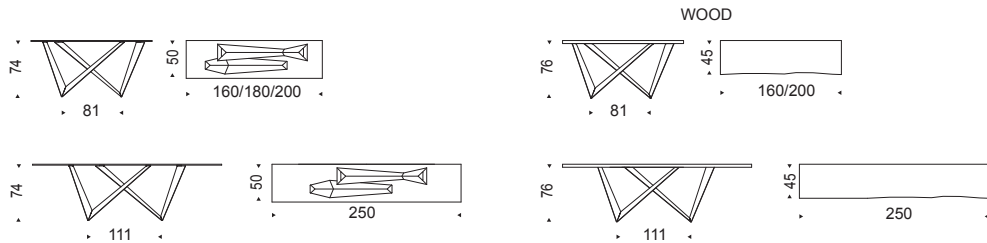



















## VALENTINOX CONSOLE

Design Emanuele Zenere

Consolle con base in acciaio inox lucido. Cilindro in Travertino, marmo nero Marquina o bianco Carrara. Piano in cristallo trasparente o fumè 12mm. Piano in cristallo trasparente o fumè 12mm. Piano in appoggio.

Console with polished stainless steel base and cylinder in Travertine, Black Marquina or white Carrara marble. Top in 12mm clear or fumè glass, laid on the base.

Consolle avec base en acier inox brillant et cylindre en Travertin, marbre noir Marquina ou blanc Carrara. Plateau en verre clair ou fumè 12mm en appui.

Consola con base en acero inox brillo. Cilindro en mármol Travertino, negro Marquina o blanco Carrara. Sobre en cristal transparente o fumè 12mm. Sobre en cristal transparente o fumè 12mm. Sobre en apoyo.

Konsole mit Basis aus glänzendem Edelsahl. Zylinder aus Travertin, schwarzem Marquina oder weißem Carrara Marmor. Platte aus Klar- oder rauchigem Glas 12mm auf dem Basis gelegt.









## VALENTINO CONSOLLE

Design Emanuele Zenere

Consolle con base in noce Canaletto o rovere bruciato e cilindro in Travertino, marmo nero Marquina o bianco Carrara. Piano in cristallo trasparente o fumè 12mm. Piano in appoggio.

Console in Canaletto walnut or burned oak and cylinder in Travertine, black Marquina or white Carrara marble. Top in 12mm clear or fumè glass, laid on the base.

Consolle avec base en noyer Canaletto ou rouvre brulé et cylindre en Travertin, marbre noir Marquina ou blanc Carrara. Plateau en verre clair ou fumè 12mm en appui.

Consola con base en nogal Canaletto o roble ahumado. Cilindro en mármol Travertino, negro Marquina o blanco Carrara. Sobre en cristal transparente o fumé 12mm. Sobre en apoyo.

Konsole mit Fuß aus Nussbaum Canaletto oder "verbrannte Eiche". Zylinder aus Travertin, schwarzem Marquina, weißem Carrara Marmor. Platte aus Klar- oder rauchigem Glas 12mm auf dem Basis gelegt.









## TOUR CONSOLLE

### Design Giorgio Cattelan

Consolle con base in acciaio verniciato gofrato graphite, gamba in noce Canaletto. Piano in cristallo trasparente, trasparente extrachiaro o noce Canaletto. Portata massima 10 kg distribuiti. Fissaggio a parete necessario.

Console with base in graphite embossed lacquered steel and leg in Canaletto walnut. Top in clear glass, extra clear glass or Canaletto walnut. Max capacity 10 kg spread load. Wall anchorage is required.

Console avec base en acier laqué gaufré graphite mat et pied en noyer Canaletto. Plateau un verre clair, extra-clair ou noyer Canaletto. Poids maximum admis 10 kg répartis. La fixation au mur est nécessaire.

Consola con base en acero barnizado gofrado graphite, pata en nogal Canaletto. Sobre en cristal transparente, transparente extraclaro o nogal Canaletto. Capacidad máxima 10 kg distribuidos. Ajuste a la pared es necesario.

Konsole mit Basis in Stahl lackiert graphite gaufriert und Bein aus Nussbaum Canaletto. Platte in transparentem oder extra hell transparentem Glas oder Nussbaum Canaletto. Maximale Belastbarkeit 10 kg (verteilt). Wandbefestigung ist notwendig.

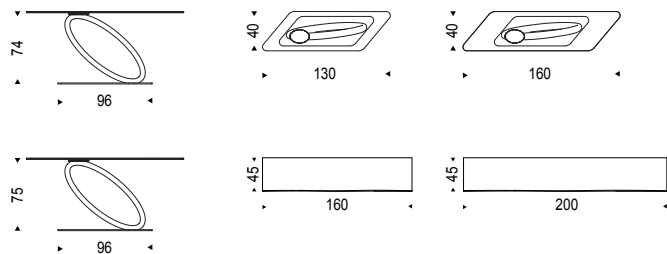















## MONACO CONSOLLE

### Design Giorgio Cattelan

Consolle con base in noce Canaletto, rovere bruciato, marmo bianco Carrara o inox. Piedi in acciaio lucido. Piano con piastre in cristallo trasparente 15mm. Piccole irregolarità di riflessione sulla base in inox sono dovute alla lavorazione manuale.

Console with base in Canaletto walnut, burned oak, white Carrara marble or stainless steel. Stainless steel feet. Top with plates in 15mm clear glass. Small reflection's irregularities on the stainless steel base are due to manual processing.

Consolle avec base en noyer Canaletto, rouvre brulé, marbre blanc Carrara ou en inox. Pieds en acier inox. Plateau avec plates en verre clair 15mm. Les petites irrégularités de réflexion sur la base en acier inox sont dues à une fabrication manuelle.

Consola con base en nogal Canaletto, roble ahumado, mármol blanco Carrara o en acero inox brillo. Sobre con pletinas en cristal transparente 15mm. Pequeñas irregularidades de reflexión en la base en acero inox están causadas por la producción manual.

Konsole mit Basis in Nussbaum Canaletto, "verbrannte Eiche", weißem Carrara Marmor oder aus Edelstahl. Füße aus Edelstahl glänzend. Platte mit metalplättchen aus Klarglas 15mm. Kleine Unregelmäßigkeiten der Reflexion auf der Edelstahl Basis sind nicht zu vermeiden, da das Teil per Hand hergestellt wird.

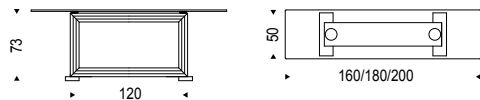















## RAPA NUI

Design **Oriano Favaretto**

Consolle con gambe in cemento verniciato in pasta nei colori bianco o grigio. Piano in cristallo 12mm trasparente, trasparente extrachiaro o in legno noce Canaletto, rovere bruciato o rovere naturale con bordo irregolare in massello. Fissaggio a parete necessario.

Console with legs in white or grey colored cement. 12mm top in clear, extra clear glass or solid Canaletto walnut, burned oak or natural oak with irregular edges. Wall anchorage is required.

Console avec base en ciment coloré blanc ou gris. Top en verre claire, extra-clair 12mm ou en bois noyer Canaletto, rovere brûlé ou rovere naturel avec bord irrégulier en massif. La fixation au mur est nécessaire.

Consola con base en cemento pintado blanco o gris. Sobre en cristal transparente 12mm, transparente extraclaro o en madera nogal Canaletto, roble ahumado o roble natural con bordes irregulares macizos. Ajuste a la pared es necesario.

Konsole mit Basis aus Zementleim in den Farben weiß oder grau. Platte in transparentem oder extra hell transparentem Glas in 12mm oder in Holz Nussbaum Canaletto, "verbrannte Eiche" oder Natur Eiche mit massiven Kanten. Wandbefestigung ist notwendig.

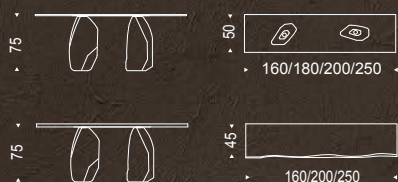







## PORTOFINO

Design Paolo Cattelan

Consolle o panca rivestita in cristallo bisellato specchiato, specchiato fumè, extrachiaro verniciato bianco.

Console or bench covered in bevelled mirrored glass, smoke-grey mirrored glass, extra clear white painted glass.

Consolle ou banc en verre biseauté miroité ou miroité fumé ou en verre extra-clair verni blanc.

Consola o banco revestida en cristal biselado espejo, espejo fumé o extraclaro barnizado blanco.

Konsole oder Bank verkleidet mit abgekantetem Glas verspiegelt, rauchig-verspiegelt, extra hell weiß Glas lackiert.





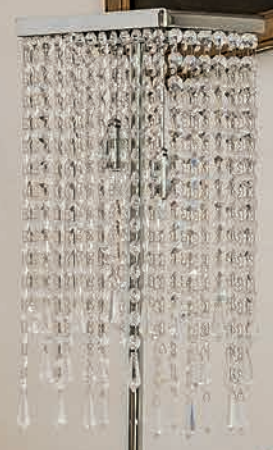



## MUSEUM CONSOLE

### Design

**G. Cattelan & A. Lucatello**

Console con base in acciaio verniciato trasparente, ramato, goffrato bianco o graphite. Cilindro in marbo bianco Carrara o Travertino naturale. Piano in cristallo trasparente 15mm.

Console with base in transparent varnished steel, copper, embossed white or graphite lacquered steel. Cylinder in natural Travertine or white Carrara marble. 15mm clear glass top.

Console avec base en acier laqué transparent, cuivre, gaufré blanc ou graphite et cylindre en marbre Travertin ou blanc Carrara. Plateau en verre clair 15 mm.

Consola con base en acero barnizado transparente, cobre, gofrado blanco o graphite. Cilindro en mármol Travertino o blanco Carrara. Sobre en cristal 15mm transparente.

Konsole mit Basis aus Metall lackiert transparent, verkupfert oder weiß oder graphite gaufriert. Zylinder aus Travertin oder weißem Carrara Marmor. Platte 15mm in Glas transparent.

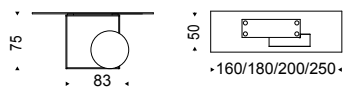







**DIAPASON**

**Design Studio Diapason**

Consolle con base in Travertino o bianco Carrara e piano in cristallo trasparente 12mm. Piano in appoggio.

Console with Travertine or white Carrara marble base. Clear glass 12mm. The top is laid on the base.

Consolle avec base en Travertin ou blanc Carrara. Plateau en verre clair 12mm. Plateau en appui.

Consola con base en mármol Travertino o blanco Carrara. Sobre en cristal transparente 12mm. Sobre en apoyo.

Konsole mit Fuß aus Travertin oder weiß Carrara Marmor. Klarglasplatte 12mm auf dem Basis gelegt.

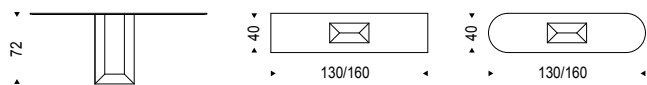

consolle DIAPASON - lamp MIDDAY - mirror MOMENT



**ELVIS CONSOLLE**

**Design Alberto Danese**

Consolle con base in acciaio inox anti-impronta e colonna in acciaio inox. Piano in cristallo trasparente.

Consolle with stainless steel anti-marks base and stainless steel column. Fixed top in 15mm clear glass or extendible version in polished white laminated.

Consolle avec base en acier inox anti empreinte et colonne en inox. Plateau en verre transparent.

Consola con base en acero inox anti huellas y columna en acero inoxidable. Sobre fijo en cristal transparente.

Konsole mit Unterbau aus Anti finger Edelstahl und Standrohr aus Edelstahl. Platte aus Klarglas transparent.

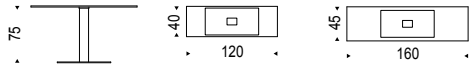

ELVIS CONSOLLE DRIVE pag. 300

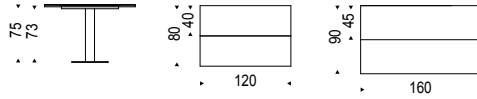

consolle ELVIS CONSOLLE - chair SAMANTHA - mirror WISH



## HORIZON

### Design Alessio Bassan

Madia/consolle/porta TV a 2 cassetti in noce Canaletto o rovere bruciato. Top in cristallo extrachiaro acidato verniciato graphite. Base in acciaio verniciato gofrato graphite. Versione A1 e A2 con ripiano inferiore in noce Canaletto o rovere bruciato.

Sideboard/console/ TV stand with 2 drawers in Canaletto walnut or burned oak. Top in graphite painted frosted extra clear glass. Graphite embossed laquered steel base. A1 and A2 versions with lower shelf in Canaletto walnut or burned oak.

Bahut/consolle avec 2 tiroirs en noyer Canaletto ou rovre broulé. Plateau en verre extra-clair dèpoli laqué graphite. Pieds en acier laqué gaufré graphite mat. Version A1 et A2 avec étagère inférieur en noyer Canaletto ou rouvre brulé.

Aparador/consola con 2 cajones en nogal Canaletto o roble ahumado. Sobre en cristal extraclaro translúcido barnizado graphite. Patas en acero barnizado gofrado graphite. Versiones A1 y A2 con estante bajo en nogal Canaletto o roble ahumado.

Anrichte mit 2 Schubladen aus Nussbaum Canaletto oder "verbrannte Eiche". Platte aus Glas extra hell geätzt graphite lackiert. FüÙe aus Stahl lackiert graphite gaufriert. Version A1 und A2 mit niedrigem Regal aus Nussbaum Canaletto oder "verbrannte Eiche".

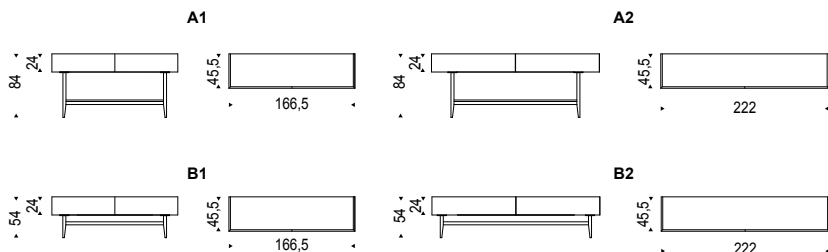











**WISH BOARD****Design Paolo Cattelan**

Specchio da parete in cristallo specchiato. Cornice in acciaio verniciato trasparente, gofrato graphite o nero. Mensola in noce Canaletto o rovere Heritage.

Wall mirror in mirrored glass. Frame in transparent varnished steel, graphite or black embossed lacquered steel. Shelf in Canaletto walnut or Heritage oak.

Miroir mural avec cadre en acier laqué transparent, gaufré graphite ou noir. Étagère en noyer Canaletto ou rovere Heritage.

Espejo de pared en cristal reflejado. Marco en acero barnizado transparente, gofrado graphite o negro. Repisa en nogal Canaletto o roble Heritage.

Wandspiegel in Glas verspiegelt. Rahmen in Metall lackiert transparent, graphite oder schwarz gaufriert. Boden in Nussbaum Canaletto oder Eiche Heritage.

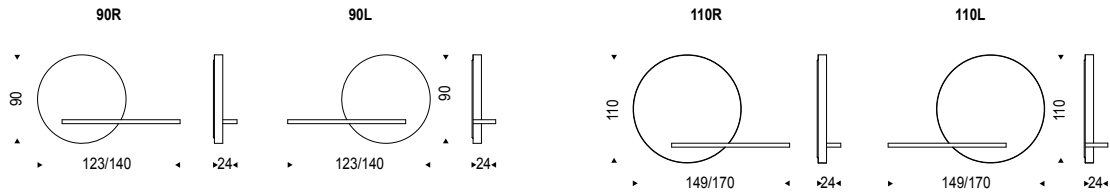

consolle WISH BOARD - coat hanger VALDO - rug HAUBUT



CONSOLLE ALLUNGABILI \_ EXTENDABLE CONSOLES



CONVIVIUM



NEMO CONSOLLE





ELVIS CONSOLLE DRIVE



300



PARTY



292



## CONVIVIUM

### Design Giorgio Cattelan

Consolle allungabile con base in acciaio verniciato gofrato bianco, graphite o inox satinato. Piano e prolunghe in laminato bianco climb, ossido grigio, noce, grigio Londra Fenix o castoro Ottawa Fenix. Inclusa borsa porta prolunghe.

Extendible console with base in white or graphite embossed lacquered steel or in satin stainless steel. Top and extensions in white climb, grey oxide, walnut, grey London Fenix or beaver Ottawa Fenix laminated wood. Bag for extensions included.

Console à rallonges avec base en acier laqué gaufré blanc, graphite ou inox satiné. Plateau et rallonges en laminé blanc climb, oxyde gris, noyer, gris Londres Fenix ou castor Ottawa Fenix. Porte rallonges compris.

Consola extensible con base en acero barnizado gofrado blanco, graphite o acero inox satinado. Sobre y extensiones en laminado blanco climb, óxido gris, nogal, gris Londres Fenix o castor Ottawa Fenix. Bolsa para extensiones incluida.

Konsole mit Verlängerungen, Basis in Stahl lackiert weiß oder graphite gaufriert oder in Edelstahl gebürstet. Platte und Verlängerungen aus Laminat in den Farben: weiß Climb, grau Oxid, Nussbaum, London grau Fenix oder Biber Ottawa Fenix. Tasche für Verlängerungen ist enthalten.

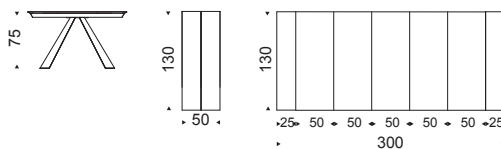
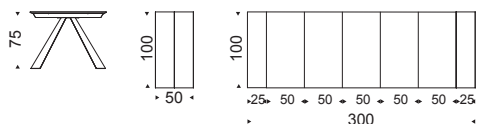

consolle extensible CONVIVIUM - chairs ISABEL, MAGDA B, BEVERLY, PATRICIA, BRIGITTA, PIUMA B - pouf BOB - lamp DREAM - bookcases SWING

















50



100



150



200



250



300







## PARTY

### Design Giorgio Cattelan

Consolle allungabile con base in acciaio verniciato gofrato bianco o graphite. Piano e prolunghe in laminato bianco climb, ossido grigio, noce, grigio Londra Fenix o castoro Ottawa Fenix. Inclusa borsa porta prolunghe.

Extendible console with base in white or graphite embossed lacquered steel. Top and extensions in white climb, grey oxide, walnut, grey London Fenix or beaver Ottawa Fenix laminated wood. Bag for extension included.

Console à rallonges avec base en acier laqué gaufré blanc ou graphite. Plateau et rallonges en laminé blanc climb, oxyde gris, noyer, gris Londres Fenix ou castor Ottawa Fenix. Porte rallonges inclus.

Consola extensible con base en acero barnizado gofrado blanco o graphite. Sobre y extensiones en laminado blanco climb, óxido gris, nogal, gris Londres Fenix o castor Ottawa Fenix. Bolsa para extensiones incluida.

Konsole mit Verlängerungen, Basis in Stahl lackiert weiß oder graphite gaufriert. Platte und Verlängerungen aus Laminat weiß Climb, grau Oxid, Nussbaum, London grau Fenix Laminat oder Biber Ottawa Fenix Laminat. Tasche für Verlängerungen ist enthalten.

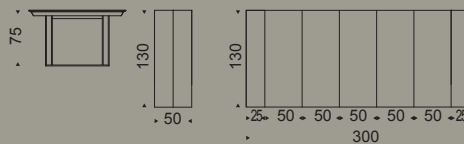
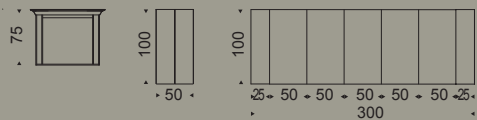















## NEMO CONSOLLE

### Design Paolo Cattelan

Consolle allungabile con base in acciaio verniciato gofrato bianco o graphite. Piano e prolunghe in laminato bianco climb, ossido grigio, noce, grigio Londra Fenix o castoro Ottawa Fenix. Inclusa borsa porta prolunghe.

Extendible console with base in white or graphite embossed lacquered steel. Top and extensions in white climb, grey oxide, walnut, grey London Fenix or beaver Ottawa Fenix laminated wood. Bag for extension included.

Console à rallonges avec base en acier laqué gaufré blanc ou graphite. Plateau et rallonges en laminé blanc climb, oxyde gris, noyer, gris Londres Fenix ou castor Ottawa Fenix. Porte rallonges inclus.

Consola extensible con base en acero barnizado gofrado blanco o graphite. Sobre y extensiones en laminado blanco climb, óxido gris, nogal, gris Londres Fenix o castor Ottawa Fenix. Bolsa para extensiones incluida.

Konsole mit Verlängerungen, Basis in Stahl lackiert weiß oder graphite gaufriert. Platte und Verlängerungen aus Laminat weiß Climb, grau Oxid, Nussbaum, London grau Fenix Laminat oder Biber Ottawa Fenix Laminat. Tasche für Verlängerungen ist enthalten.

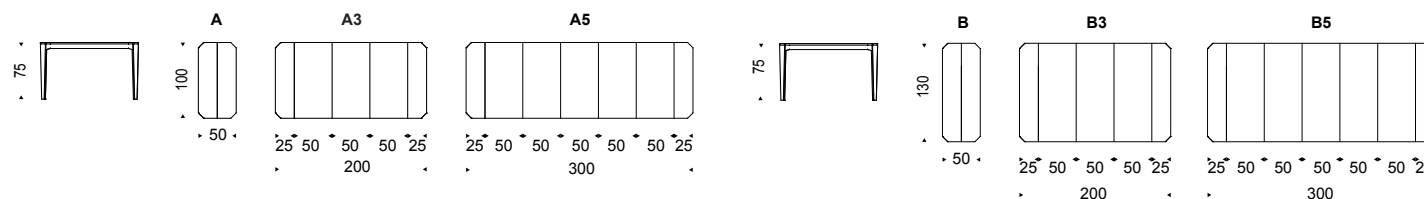















## ELVIS CONSOLLE

Design **Alberto Danese**

Tavolo/consolle con base in acciaio inox anti-impronta e colonna in acciaio inox. Piano in cristallo trasparente o piano e prolunga in laminato bianco.

Table/console with stainless steel anti-marks base and stainless steel column. Fixed top in 15mm clear glass or extendible version in polished white laminated.

Table/consolle avec base en acier inox anti empreinte et colonne en inox. Plateau en verre transparent ou laminé brillant blanc.

Mesa/Consola con base en acero inox anti huellas y columna en acero inoxidable. Sobre fijo en cristal transparente o sobre extensible en laminado blanco brillo.

Tisch/Konsole mit Unterbau aus Anti finger Edelstahl und Standrohr aus Edelstahl. Platte aus Klarglas transparent oder Laminat weiß.

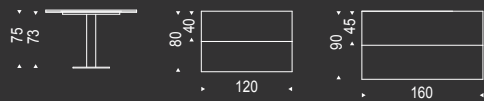

ELVIS CONSOLLE pag. 279









SCRIVANIE\_DESKS



BATIK 320



DAVINCI 328



DYNO DESK 324



QWERTY 316



STORM 322





ISLAND 330



LAP 327



NASDAQ 304



VEGA 310



VEGA 312



## NASDAQ

Design Paolo Cattelan

Scrivania con cassettiera in legno noce Canaletto o rovere Heritage. Gamba in acciaio verniciato gofrato graphite.

Desk with drawers in Canaletto walnut or Heritage oak. Leg in graphite embossed lacquered steel.

Bureau avec tiroirs en noyer Canaletto ou rouvre Heritage. Pied en acier gaufré verni graphite.

Escritorio con cajones en madera nogal Canaletto o roble Heritage. Pata en acero barnizado gofrado graphite.

Schreibtisch mit Schubladen aus Nussbaum Canaletto oder Eiche Heritage. Bein aus Stahl lackiert graphit gaufriert.

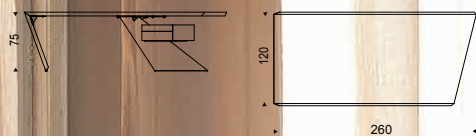
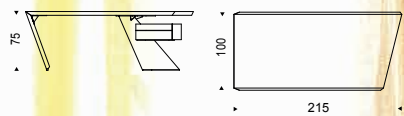









desk NASDAQ heritage oak

















## VEGA

### Design Giorgio Cattelan

Scrivania in acciaio inox lucido o rivestita in noce Canaletto o rovere bruciato con interno verniciato graphite opaco. Accessori disponibili: dattilo nella stessa finitura della scrivania (deve essere sorretto da cassettera), cassettera su ruote a due cassetti con struttura verniciata argento o graphite e frontale in cuoio come da campionario, pad in cuoio come da campionario.

Desk in polished stainless steel or covered in Canaletto walnut or burned oak with inner sides painted in matt graphite. Optional accessories: peninsula in the same finish as the desk (to be supported by drawer-unit), two-drawer-unit on wheels with silver or graphite lacquered structure and front part of the drawers in leather as per sample card, pad in leather as per sample card.

Bureau en acier inox brillant ou revêtu en noyer Canaletto ou rouvre brûlé et intérieur verni graphite mat. Accessoires disponibles: retour dans la même finition du bureau (doit être soutenu par le meuble à tiroirs), meuble à deux tiroirs sur roulettes avec structure argent ou graphite et front des tiroirs en cuir selon échantillons, tapis en cuir selon échantillons.

Escritorio en acero inox brillo o revestido en nogal Canaletto o roble ahumado con interior barnizado graphite mate. Accesorios disponibles: dactilo en el mismo acabado del escritorio (debe ser sostenido de cajonera), cajonera sobre ruedas a dos cajones con estructura pintada plata o graphite y frontales en cuero según muestrario. Pad en cuero según muestrario.

Schreibtisch aus Edelstahl glänzend oder bezogen mit Nussbaum Canaletto oder "verbrannte Eiche", innen lackiert graphite matt. Verfügbarer Wohnzubehören: Daktylus in den Ausführungen der Schreibtisch, (unbedingt auf das Schubladenelement zu befestigen), Schubladenelement auf Rollen mit zwei Schubladen, Korpus lackiert silber oder graphite und Fronten aus Kernleder laut Musterkarte, PAD aus Kernleder laut Musterkarte.

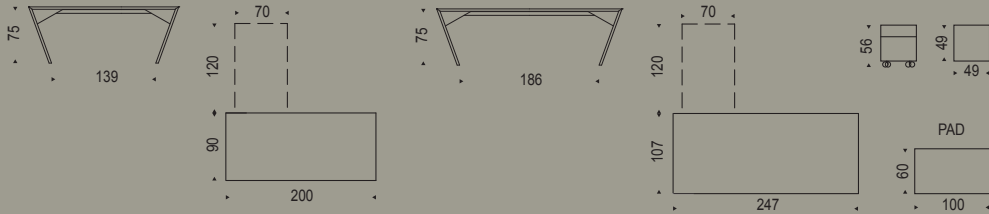



















VCSA 115



It hand  
 could be  
 in key.

This is what  
 the picture.

I will look like in

A coin  
 could be  
 in key.

This is what  
 the picture.





## QWERTY

### Design Andrea Lucatello

Scrivitoio con struttura in acciaio verniciato bianco o graphite opaco e profili in acciaio inox. Piano in MDF laccato bianco o graphite gofrato fine. PAD in cuoio nei colori come da campionario.

Desk with matt white or graphite painted frame and profile in stainless steel. Top in lacquered white or graphite embossed MDF. Leather pad as per sample card.

Bureau, structure en acier laqué blanc ou graphite mat et profil en acier inox. Plateau en mdf laqué blanc ou graphite gaufré. Sous-main en cuir selon échantillons.

Escritorio con estructura en acero barnizado blanco o graphite opaco y perfil en acero inox. Sobre en mdf lacado blanco o graphite gofrado fine. Pad en cuero de color según muestrario.

Schreibtisch mit Struktur aus lackiertem Stahl matt weiss oder matt graphite. Profil aus Edelstahl. Platte aus MDF weiss oder graphite lackiert gaufriert. PAD in Kernleder, Farbe laut Musterkarte.

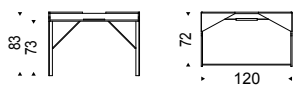















## BATIK

### Design Andrea Lucatello

Scrivania con gambe in acciaio verniciato gofrato bianco o graphite con inserti in noce Canaletto. Piano in legno verniciato gofrato bianco o graphite con contenitore in noce Canaletto.

Desk with base in white or graphite embossed lacquered steel with profiles in Canaletto walnut. Top in white or graphite embossed lacquered wood with container in Canaletto walnut.

Bureau avec structure en acier laqué gaufré blanc ou graphite et profils en noyer Canaletto. Plateau en bois laqué gaufré blanc ou graphite avec conteneur en noyer Canaletto.

Escritorio con estructura en acero barnizado gofrado blanco o graphite con detalles en nogal Canaletto. Sobre en madera barnizado gofrado blanco o graphite y contenedor en nogal Canaletto.

Schreibtisch mit Struktur in Stahl lackiert weiß oder graphite gaufriert und Profil aus Nussbaum Canaletto. Platte in Holz lackiert weiß oder graphite gaufriert und Raum in Nussbaum Canaletto.

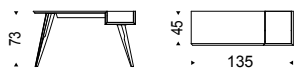







## STORM

### Design Andrea Lucatello

Scrivania con struttura e piano in acciaio verniciato gofrato bianco o graphite. Pad in cuoio nei colori come da campionario.

Desk with frame and top in white or graphite embossed lacquered steel. Leather pad as per sample card.

Bureau avec structure et plateau en acier laqué gaufré blanc ou graphite. Sous-main en cuir selon échantillons.

Escritorio con estructura en acero barnizado gofrado blanco o graphite. Pad en cuero de color según muestrario.

Schreibtisch mit Basis und Platte aus Edelstahl lackiert weiß oder graphite gaufriert. Pad in Kernleder, Farbe laut Musterkarte.









## DYNO DESK

### Design Paolo Cattelan

Piano scrittoio in legno laccato bianco opaco con sostegno laterale in acciaio verniciato bianco opaco. Da aggiungersi agli elementi Dyno a 4 o 8 cassetti.

Desk in matt white lacquered wood with lateral support in matt white lacquered steel. To be laid on the top of Dyno 4 or 8 drawers.

Bureau en bois laqué blanc matt avec support lateral en acier verni blanc matt. À appuyer sur le Dyno 4 ou 8 tiroirs.

Escritorio en madera lacado blanco mate con soporte lateral en acero barnizado blanco mate. A poner sobre de los artículos Dyno 4 o 8 cajones.

Schreiben Oberfläche in matt weiß lackiertem Holz mit Seitenhalt in matt weiß lackiertem Stahl. Zu den Elementen Dyno bis 4 oder 8 Schubladen zugesetzt.









## LAP

### Design Giorgio Cattelan

Tavolino fianco divano o porta notebook regolabile in altezza. Piano in cristallo trasparente 12mm rettangolare o sagomato. Base in acciaio inox con gamba cromata o rivestita in cuoio come da campionario.

Side table or lap-top unit adjustable in height. Top in rectangular or shaped 12mm clear glass. Stainless steel base with chromed leg or covered in leather as per sample card.

Table coté/canapé ou porte-ordinateur réglable en hauteur. Top en verre transparent 12mm rectangulaire ou façonné. Base en acier inox avec pied chromé ou revêtu en cuir selon échantillons.

Mesita o porta-ordenador regulable en altura. Sobre en cristal transparente 12mm rectangular o sagomado. Base en acero inox con pata cromada o revestida en cuero según muestrario.

Couchtisch oder Computertisch mit höhenverstellbarem Gestell. Platte aus rechtwinkeligem oder nierenförmigem Klarglas 12mm. Bodenplatte aus Edelstahl und Bein aus verchromtem Stahl oder mit Lederbezug laut Musterkarte.

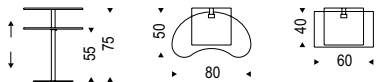







## DAVINCI

### Design G. Plazzogna

Scrivitoio in noce Canaletto e laccato opaco grey con due cassetti.

Desk in Canaletto walnut and grey lacquered wood with two drawers.

Bureau en noyer Canaletto et laqué grey avec 2 tiroirs.

Escritorio en nogal Canaletto y lacado grey con 2 cajones.

Schreibtisch in Holz grey lackiert und Nußbaumholz Canaletto mit zwei Schubladen.







desk DAVINCI - chair LULU' - lamp LITTLE FLAG - bookcase LOFT







**ISLAND****Design Paolo Cattelan**

Scrivitoio con base in acciaio inox. Piano in cristallo temperato extrachiaro verniciato bianco 12mm oppure in noce Canaletto.

Desk with stainless steel base. Top in extra clear white painted glass (12mm tempered) or Canaletto walnut.

Bureau avec base en acier inox. Plateau en verre trempé 12mm extra-clair verni blanc ou noyer Canaletto.

Escritorio con base en acero inox. Sobre en cristal templado 12mm extraclaro barnizado blanco o nogal Canaletto.

Schreibtisch mit Basis aus Edelstahl. Platte aus Sicherheitglas 12mm extra hell weiss oder Nussbaum Canaletto.

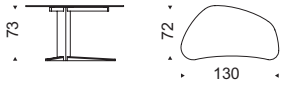



# BOOK 2 INDEX

## SEDIE

Chairs\_Chaises  
Sillas\_Stühle\_Стулья

### PAGE

46	AGATHA FLEX
50	AGATHA FLEX SLIM
154	ALESSIA
94	AMY
138	ANGEL
83	ANNA
86	ANNA H
22	ARCADIA
26	ARCADIA H
158	ARIA
42	AURELIA
162	BELUGA
52	BETTY
134	BEVERLY
140	BRIGITTA
100	CAROL
120	CINDY
92	DAISY
160	EASY
102	ELEONOIRE
117	HELENA
12	ISABEL
14	ISABEL H
18	ISABEL ML
20	ISABEL ML H
150	KAORI
104	KATE
142	LADY
136	LARA
118	LINDA
58	LIZ
63	LIZ H
115	LULÙ
30	MAGDA
122	MARGOT
126	MARGOT H
129	MARGOT XL
81	MAYA FLEX
80	MAYA FLEX ML
72	MULAN
68	MUSA
144	NINA
146	NINA XL
54	PATRICIA
130	PIUMA
90	SALLY

37	SOFIA
41	SOFIA H
64	TOSCA
65	TOSCA H
75	TYLER
78	TYLER WHEELS
111	VITA
113	VITA C
110	VITA H
112	VITA HC
96	VITTORIA

## SEDIE CON BRACCIOLI

Chairs with arms  
Chaises avec accoudoirs  
Sillas con brazos  
Stühle mit Armlehne  
Стулья с подлокотниками

### PAGE

82	ANNA B
87	ANNA HB
116	HELENA B
12	ISABEL B
16	ISABEL HB
19	ISABEL ML B
19	ISABEL ML HB
106	KATE B
119	LINDA B
58	LIZ B
62	LIZ HB
114	LULÙ B
32	MAGDA B
128	MARGOT XLB
73	MULAN B
70	MUSA B
132	PIUMA B
108	SAMANTHA
36	SOFIA B
41	SOFIA HB
74	TYLER B
79	TYLER WHEELS
66	TOSCA B
66	TOSCA HB

## SGABELLI

Bar Stools\_Tabourets\_Tabouretes  
Barhocker\_Барные Стулья

### PAGE

176	ALESSIO
182	ANNA SGABELLO
190	ARIA SGABELLO
178	BOSS
180	CINDY SGABELLO
181	CLIFF
184	COCO
186	KATE SGABELLO
183	KISS
174	MAGDA SGABELLO
187	PENNY
188	PEPE
166	TOTO
170	VITO
172	VITO X

## POLTRONCINE

Easy Chairs\_Petits Fauteuils  
Butacas\_Sessel\_Кресла

### PAGE

196	ALASKA
198	CORNELIA

## POUFF

Pouf\_Poufs\_Pouf\_Puff\_Пуф

### PAGE

194	BOB
192	KUBO
193	PINKO

## CHAISE LONGUE

Chaise Longue\_Chaises Longues  
Chaise Longue\_Chaise Lounge  
Шезлонги

### PAGE

204	CASANOVA
208	DONOVAN
200	SYLVESTER



# BOOK 3 INDEX

## LIBRERIE

Bookcases\_Bibliothèques  
Estanterías\_Bücherregale  
Библиотеки

PAGE	
8	AIRPORT
50	DNA
314	DROP
44	ESTORIL
36	FIFTY
24	GIOTTO
46	JOKER
32	LOFT
28	PIQUANT
40	SWING
18	WALLY

## MENSOLE

Shelves\_Étagères  
Estantes\_Einlegeboden\_Полки

PAGE	
54	CROSS
52	PENDOLA
202	WISH BOARD

## MADIE

Sideboards\_Crédences  
Aparadores\_Sideboards\_Буфеты

PAGE	
118	ARABESQUE
100	CONTINENTAL
122	CHELSEA
126	DAKOTA
58	EUROPA
78	FUTURA
92	HILTON
130	HORIZON
64	KAYAK
70	LABYRINTH
104	NEBRASKA
108	OXFORD
312	PORTOS
86	PRISMA
136	SENECA
82	TORINO
74	TROPEZ
116	WEBBER

## PORTA TV

Tv Units\_Porte-Tv\_Muebles Tv  
Tv-Träger\_Подставка Для ТВ

PAGE	
16	AIRPORT
144	BOXER
130	HORIZON B
140	LINK
149	PANORAMA
150	PLAY
136	SENECA
148	VISION

## VETRINE

Showcases\_Vitrines\_Vitrinas  
Vitrinen\_Витрины

PAGE	
156	CHANTAL
154	CHARME
164	CONCERTO
168	MINI DECOR
161	OPEN WIND
162	SABA
166	SHIELD
160	WIND

## SPECCHI

Mirrors\_Miroirs\_Espejos  
Spiegel\_Зеркала

PAGE	
184	DIAMOND
190	EGYPT
176	EMERALD
186	EXCALIBUR
210	JERSEY
208	KENYA
214	MOMENT ☉
206	PASHÀ
196	PHOTO
204	REBUS
172	REGAL
212	RING
180	STRIPES
192	TAXEDO
216	TIMES ☉
198	WISH
202	WISH BOARD

## APPENDIABITI

Coats Hanger Stands\_Porte Manteaux  
Percheros\_Kleiderständer\_Вешалки

PAGE	
322	AIR
333	BAUM
330	BOTTONE
326	OSCAR
332	SIPARIO
324	VALDO
328	YANNIK

## TAPPETI

Rugs\_Tapis\_Alfombras  
Teppiche\_Ковры

PAGE	
337	CHENNAI
	DARWIN
	DELHI
	HALIBUT
	JAIPUR
	MAPOON
	RUBIK

## TAVOLINI

Coffee Tables\_Tables Basses  
Mesitas Couchtische\_Журнальные Столики

PAGE	
258	ALIEN
275	ARENA
254	ATLAS
276	ATOLLO
305	AXO
236	BILLY
238	BILLY KERAMIK
240	BILLY WOOD
234	COBRA INOX
248	DADOX
256	DIELLE
288	FALCO
302	GLISS
226	GLOBE
252	HELIX
308	HUGO TAVOLINO
282	JOLLY
246	KADIR
284	KAOS
306	LAP
290	LASER
250	LEVANTE
270	LINGOTTO
292	LITRO
266	LOTHAR
296	OTTO
264	PANAMA
272	PARSIFAL
294	PAT
268	PENTA
298	PEYOTE
278	RIO
224	SAMBA
260	SCACCO
262	STONE
300	THEO
304	UP
220	VIETATO BAGNARSI
228	VIPER
244	YO-YO
280	ZEN

## CARRELLI

Trolleys\_Chariots\_Carritos  
Servierwagen\_Сервировочные Столики

PAGE	
316	BRANDY
318	MOJITO
319	MOJITO WOOD
320	PROFIL BAR

## COMPLEMENTI

Complements\_Compléments  
Complementos\_Wohnzubehör  
Мебельные Аксессуары

PAGE	
322	AIR
330	BOTTONE
314	DROP
334	JERRY
296	OTTO
312	PORTOS
328	YANNIK



# BOOK 4 INDEX

## LAMPADE A SOSPENSIONE

Pendant Lamps  
Lustre\_Lámparas de techo  
Hängelampen\_Люстры

### PAGE

48	APOLLO
80	ASTRA
72	BABAN
30	BOLERO
64	CALIMERO
20	CRISTAL
78	CUPOLONE
82	DREAM
68	ECLIPSE
16	GALAXY
40	HUBLLOT
26	KIDAL
44	LIM
46	LIM Z
54	MEDUSA
74	MIDDAY
58	OKTOPUS
62	TOPAZ
10	VENEZIA
36	ZEPPELIN

## LAMPADE DA TAVOLO

Table Lamps\_Lampes de table  
Lámparas de sobremesa  
Tischlampen\_Настольные Лампы







### PAGE

98	BOLERO
134	CALIMERO
88	MAMBA
144	MEDUSA
146	MIDDAY
94	ORION
136	PLUTO
90	SEVEN
128	VENEZIA
140	ZEPPELIN

## LAMPADE DA TERRA

Floor Lamps\_Lampes de sol  
Lámparas\_Stehlampen  
Напольные Лампы

### PAGE

118	ASTRA ARC 
100	BOLERO
132	CALIMERO
108	COMPASS
122	FLAG 
116	LITTLE FLAG 
114	KARIBÙ
142	MEDUSA
120	MIDDAY ARC 
96	ORION
92	SEVEN 
126	SIPARIO LIGHT
110	THRILLER
130	VENEZIA
104	ZED 



# BOOK 5 INDEX

---

## LETTI

Beds\_Lits\_Camas\_Betten\_Кровати

### PAGE

34	ADAM
66	ALEXANDER 
86	BJORN 
8	DYLAN
80	FRANKLYN
76	LOGAN
30	LUKAS
70	MARSHALL 
42	MATISSE 
16	NELSON
50	PATRICK 
24	WILLIAM 

## COMÒ COMODINI

Chests Of Drawers, Nightstands

Chevets, Commodes

Cómodas, Mesitas de noche

Kommoden, Nachttische

Тумбочки, Комоды

### PAGE

64	CLUB
84	DANDY
48	DORIAN
56	DYNO
62	DYNO DESK
90	NIGEL



1  
TABLES

cattelan  
italia

---

CATTELANITALIA.COM



**CATTELAN ITALIA** SPA - via pilastri 19 - 36010 Carrè / Vicenza - Italy  
phone +39 0445 318711 - fax +39 0445 314289 - email: info@cattelanitalia.com