

cattelan  
italia

---

8

COLLECTION 2018

# INDEX BOOK 8

## TAVOLI

Dining Tables\_Tables  
Mesas\_Tische\_Стол

84	DUFFY WOOD
50	GORDON OUTDOOR
76	LINUS WOOD
20	PLANER
26	PLANER KERAMIK
66	PLANER ROUND
70	PLANER ROUND KERAMIK
68	PLANER ROUND KER-WOOD
12	PLANER WOOD
38	SKORPIO
52	SKORPIO ROUND KER-WOOD
48	SKORPIO WOOD-C
44	SKORPIO KERAMIK
36	SKYLINE
72	SKYLINE ROUND KERAMIK
34	SKYLINE KERAMIK
30	SKYLINE WOOD
56	SOHO KERAMIK
60	SOHO KER-WOOD

## TAVOLI ALLUNGABILI

Extendible Dining Tables\_Tables à rallonges  
Mesas Extensibles\_Verlängbare Tische  
Стол с раскладкой

86	DUFFY KERAMIK DRIVE
90	DUFFY WOOD DRIVE
82	LINUS KERAMIK DRIVE
78	LINUS WOOD DRIVE

## CONSOLLE ALLUNGABILI

Extendible Console\_Console à rallonges  
Consola Extensibles\_Verlängbare Konsolen  
Консоли с раскладкой

92	CONVIVIUM
----	-----------

## CONSOLLE

Consoles\_Consoles  
Consolas\_Konsolen\_Консоли

112	SKYLINE CONSOLLE
110	WESTIN

## SCRIVANIA

Desk\_Bureaux\_Escritorio\_Schreibtische  
Письменные Столы

102	MALIBÙ
106	STORM
98	WALL STREET

## SEDIE

Chairs\_Chaises\_Sillas\_Stühle\_Стулья

134	BELINDA
118	DIANA
130	INDY
140	KAY
138	KAY COUTURE
114	KELLY
122	MAGDA COUTURE
126	WANDA

## SGABELLI

Stools\_Tabourets\_Tabouretes  
Barhocker\_Барные Стулья

146	AXEL-X
144	DUMBO SGABELLO
150	MAGDA COUTURE SGABELLO

## POLTRONCINA

Lounge Chair\_Petit Fauteuil  
Butaca\_Sessel\_Кресла

142	DUMBO LOUNGE
-----	--------------

## MADIE

Sideboards\_Crédences  
Aparadores\_Sideboards\_Буфеты

152	ARIZONA
156	ASTON
168	EUROPA KERAMIK
160	PADDOCK

## LIBRERIE

Bookcases\_Bibliothèques  
Estanterías\_Bücherregale\_Библиотеки

172	AIRPORT
180	FIFTY
182	HARLEM
186	TRESOR
176	WALLY

## PORTA TV

Tv Units\_Porte-Tv\_Muebles Tv  
Tv-Träger\_Подставка Для ТВ

164	PADDOCK TV
-----	------------

## TAVOLINI

Coffee Tables\_Tables Basses  
Mesitas\_Couchtische\_Журнальные Столики

194	BILLY
195	BILLY KERAMIK
198	CARRÉ
210	MIDA
206	OSLO
202	SKYLINE TAVOLINO

## SPECCHI

Mirrors\_Miroirs\_Espejos\_Spiegel\_Зеркала

192	EMERALD
252	IMAGE
190	WISH

## LAMPADE

Lamps\_Lustres\_Lámparas  
Hängelampen\_Люстры

212	CLOUDINE
238	FISHERMAN
218	LANCELOT
234	MAMBA
240	MANHATTAN
226	MELODY
216	PHOENIX
242	SAYONARA
230	SUNSET
232	TRAMONTO
236	TUCSON
222	TWISTER

## CABINA ARMADIO

Walk-in closet\_Penderie\_Ropero  
Begehbare Einbauschränk\_кладовка

244	NIGHTPORT
-----	-----------



**TAVOLI  
TABLES**



DUFFY WOOD page 84



LINUS WOOD page 76



PLANER page 20



SKORPIO KERAMIK page 44



SKYLINE page 36



SKYLINE KERAMIK page 34

**TAVOLI TONDI  
ROUND TABLES**



PLANER ROUND page 66



PLANER ROUND KERAMIK page 70



PLANER ROUND KER-WOOD page 68

**TAVOLI ALLUNGABILI  
EXTENDIBLE  
DINING TABLES**



DUFFY KERAMIK DRIVE page 86



DUFFY WOOD DRIVE page 90



LINUS KERAMIK DRIVE page 82

**CONSOLLE  
CONSOLES**



SKYLINE CONSOLLE page 112



WESTIN page 110



PLANER KERAMIK

page 26



PLANER WOOD

page 12



SKORPIO

page 38



SKORPIO WOOD-C

page 48



SKYLINE WOOD

page 30



GORDON OUTDOOR

page 50

**OUTDOOR**



SKORPIO ROUND KER-WOOD

page 52



SKYLINE ROUND KERAMIK

page 72



SOHO KERAMIK

page 56



SOHO KER-WOOD

page 60



LINUS WOOD DRIVE

page 78

**CONSOLLE ALLUNGABILI  
EXTENDIBLE CONSOLE**



CONVIVIAM



page 92

**SCRIVANIA  
DESK**



MALIBÙ

page 102



STORM

page 106



WALL STREET

page 98

**SEDIE  
CHAIRS**



BELINDA

page 134



DIANA

page 118



INDY

page 130



MAGDA B COUTURE

page 122



WANDA

page 126

**MADIE  
SIDEBOARDS**



ARIZONA

page 152



ASTON

page 156



EUROPA KERAMIK

page 168

**SPECCHI  
MIRRORS**



EMERALD

page 192



IMAGE

page 252



WISH

page 190



KAY

page 140



KAY COUTURE

page 138



KELLY

page 114



MADGA COUTURE

page 124



**SGABELLI  
STOOLS**

AXEL-X

page 146



DUMBO SGABELLO

page 144



MAGDA COUTURE  
SGABELLO

page 150



PADDOCK

page 160

**PORTA TV  
TV UNIT**



PADDOCK TV

page 164

**POLTRONCINA  
LOUNGE CHAIRS**



DUMBO LOUNGE

page 142

LIBRERIE  
BOOKCASES



AIRPORT

page 172



FIFTY

page 180



HARLEM

page 182

TAVOLINI  
COFFEE TABLES



BILLY

page 194



BILLY KERAMIK

page 195



CARRÈ

page 198

LAMPADE A  
SOSPENSIONE  
PENDANT LAMPS



CLOUDINE

page 212

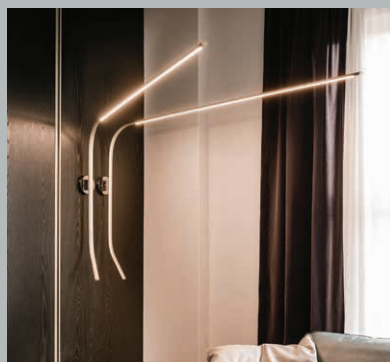

FISHERMAN

page 238



LANCELOT

page 218

LAMPADE  
DA TERRA  
WALL LAMPS



MANHATTAN

page 240



SAYONARA

page 242



TRAMONTO

page 232





TRESOR

page 186



WALLY

page 176

CABINA ARMADIO  
WALK-IN CLOSET



NIGHTPORT

page 244



MIDA

page 210



OSLO

page 206



SKYLINE TAVOLINO

page 202



MELODY

page 226



PHOENIX

page 216



SUNSET

page 230



TWISTER

page 222



TUCSON

page 236

LAMPADE DA TAVOLO  
TABLE LAMPS

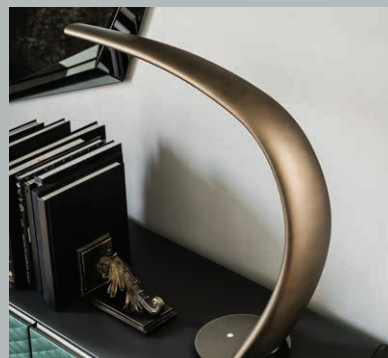

MAMBA

page 234



SUNSET

page 230





## PLANER WOOD

### Design Paolo Cattelan

Tavolo con base in acciaio verniciato gofrato titanio, graphite o nero o Brushed Bronze. Versione "B": piano a botte con bordi bisellati in noce Canaletto o rovere bruciato. Versione "C": piano in noce Canaletto con profilo inferiore arrotondato e verniciato nero o Olmo tinto poro aperto nero opaco con profilo inferiore arrotondato verniciato Brushed Bronze.

Table with base in titanium, graphite or black embossed lacquered steel or Brushed Bronze. Version "B": barrel top with angled edges in Canaletto walnut or burned oak. Version "C": top in Canaletto walnut with black lacquered and rounded lower profile or open pore matt black Elm with Brushed Bronze lacquered and rounded lower profile.

Table avec base en acier gaufré titane, graphite ou noir ou Brushed Bronze. Version "B": plateau avec bords biseauté en noyer Canaletto ou rouvre brûlé. Version "C": plateau en noyer Canaletto avec profil inférieur arrondi laqué noire ou Orme laqué noir opaque pore ouvert avec profil inférieur arrondi laqué Brushed Bronze.

Mesa con base en acero barnizado gofrado titanio, graphite o negro o Brushed Bronze. Versión "B": sobre con bordes biselados en nogal Canaletto o roble ahumado. Versión "C": sobre en nogal Canaletto y perfil inferior redondeado barnizado negro o Olmo barnizado negro mate a poro abierto y perfil inferior redondeado barnizado Brushed Bronze.

Esstisch mit Basis aus Stahl lackiert Titan, graphite oder schwarz gaufriert, oder Brushed Bronze. Version "B": Platte mit schrägen Kanten aus Nussbaum Canaletto oder "verbrannte Eiche". Version "C": Platte aus Nussbaum Canaletto mit schwarz lackierten abgerundeten Profil oder Ulme offenporig lackiert schwarz matt mit Brushed Bronze lackierten abgerundeten Profil.

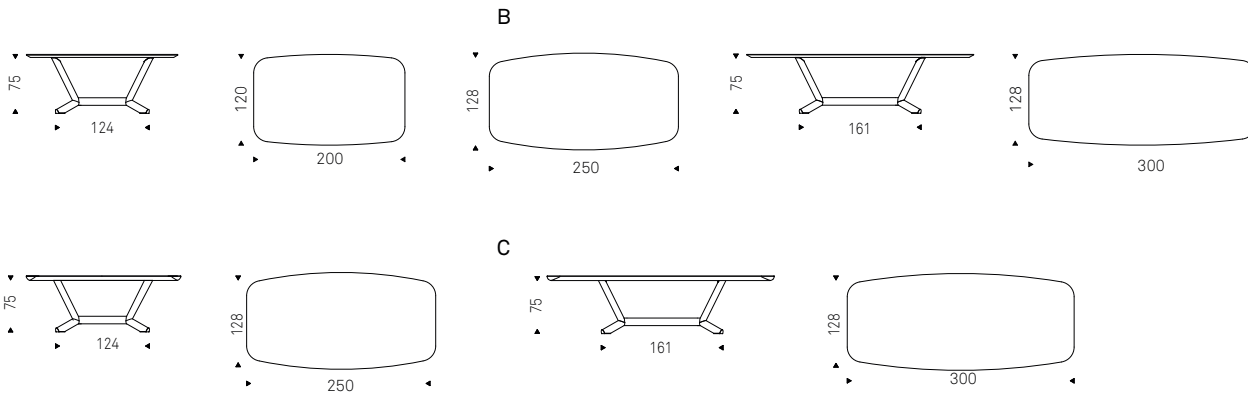



PLANER WOOD table with black base, version "C" top in matt black Elm with Brushed Bronze profile  
WANDA chair in soft leather 973 Nero - PHOENIX lamp - TIFFANY sideboards in soft leather 944 Bordeaux



PLANER WOOD table with black base, version "C" top in matt black Elm with Brushed Bronze profile - ARCADIA chairs in soft leather 948 Lino and wenghè frame  
PHOENIX lamp - TIFFANY sideboards in soft leather 944 Bordeaux











PLANER WOOD table with black base and "C" version top in Walnut Canaletto with black profile



## PLANER

### Design Paolo Cattelan

Tavolo con base in acciaio verniciato gofrato titanio, graphite o nero o Brushed Bronze. Piano in cristallo 15mm trasparente, trasparente extrachiaro, trasparente extrachiaro con bordi bisellati inversi o in cristallo specchiato bronzo o specchiato fumè. I piani 182x90 e 200x106 hanno spessore 12mm. Piano in appoggio.

Table with base in titanium, graphite or black embossed lacquered steel or Brushed Bronze. 15mm top in clear, extra clear, extra clear glass with reversed bevelled edges, bronze mirrored or fumè mirrored glass. Glass top 12mm on 182x90 and 200x106 versions. The top is laid on the base.

Table avec base en acier gaufré titane, graphite ou noir ou Brushed Bronze. Plateau en verre clair 15 mm, extra-clair, extra-clair avec bords biseautés inversés ou en verre miroité bronze ou miroité fumé. Les plateaux 182x90 et 200x106 sont de 12mm. Plateau d'appui.

Mesa con base en acero barnizado gofrado titanio, graphite o negro o Brushed Bronze. Sobre en cristal 15mm transparente, transparente extraclaro, transparente extraclaro con bordes biselados inversos o en cristal reflejado bronzo o reflejado fumé. Los sobres 182x90cm y 200x106cm son de 12mm. Sobre en apoyo.

Esstisch mit Basis aus Metall lackiert Titan, graphite oder schwarz gaufriert, oder Brushed Bronze. Platte aus Glas transparent, extra hell transparent, extra hell mit umgekehrten abgeschrägten Kanten oder aus Glas verspiegelt Bronze oder verspiegelt fumé 15mm. Platten in 182x90 und 200x106 haben 12 mm Dicke. Platte auf die Basis gelegt.

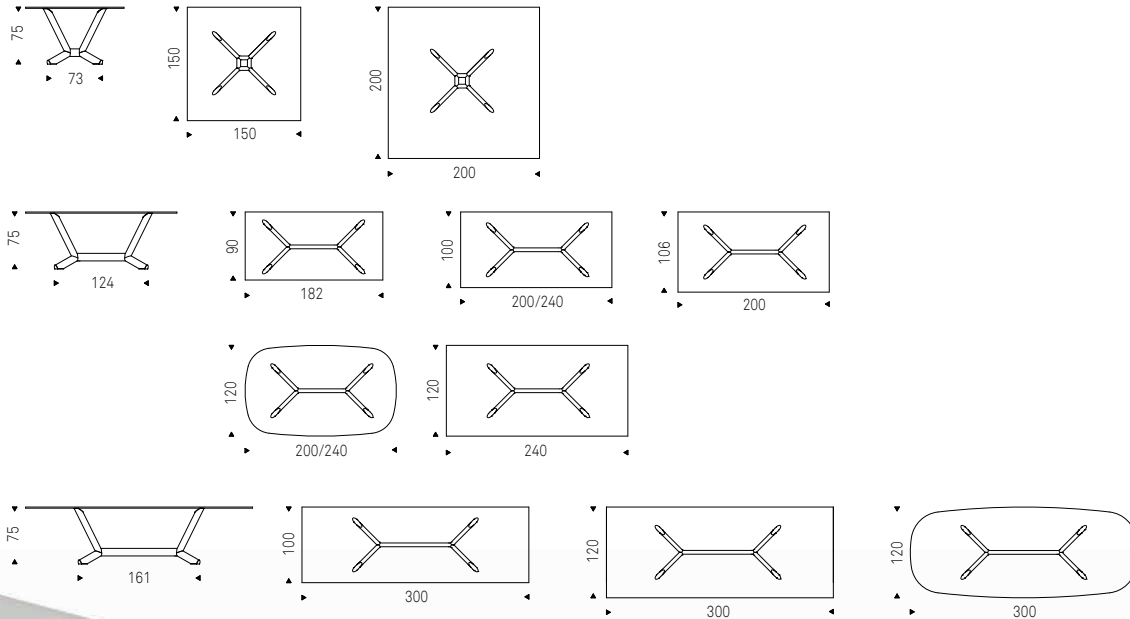



PLANER table with Brushed Bronze base and extra clear glass top - BELINDA chairs in soft leather 951 Castoro and black frame  
CLOUDINE S12 lamp in Iride glass - FIFTY bookcase in bronze finish



A built-in shelving unit with three vertical columns of brown shelves. The left column contains a stack of books including 'GIRLS ALONE', a colorful parrot figurine on a branch, and another stack of books including 'ENGLAND'. The middle column contains a stack of books including 'Ghana', a small golden shell-like object, and a stack of three small black boxes with gold trim. The right column contains three small black figurines, a small lamp, and a stack of three small black boxes with gold trim. The shelves are set against a dark wood-grain wall.







PLANER table with black base and fumè mirrored glass top





## PLANER KERAMIK

### Design Paolo Cattelan

Tavolo con base in acciaio verniciato goffrato titanio, graphite o nero o Brushed Bronze. Piano in ceramica Marmi nei colori Calacatta, Alabastro, Ardesia, Golden Calacatta opaco, Golden Calacatta lucido, Portoro opaco, Portoro lucido, Sahara Noir lucido o ceramica Brown Zinc.

Table with base in titanium, graphite or black embossed lacquered steel or Brushed Bronze. Top in ceramic Marmi Calacatta, Alabastro, Ardesia, matt Golden Calacatta, glossy Golden Calacatta, matt Portoro, glossy Portoro, glossy Sahara Noir or Brown Zinc.

Table avec base en acier gaufré titane, graphite ou noir ou Brushed Bronze. Plateau en céramique Marmi dans les couleurs Calacatta, Alabastro, Ardesia, Golden Calacatta opaque, Golden Calacatta brillant, Portoro opaque, Portoro brillant, Sahara Noir brillant ou Brown Zinc.

Mesa con base en acero barnizado gofrado titanio, graphite o negro o Brushed Bronze. Sobre en cerámica Marmi colores Calacatta, Alabastro, Ardesia, Golden Calacatta mate, Golden Calacatta brillo, Portoro mate, Portoro brillo, Sahara Noir brillo o cerámica Brown Zinc.

Esstisch mit Basis aus Stahl lackiert Titan, graphite oder schwarz gaufriert oder Brushed Bronze. Platte in Keramik Marmi in den Farben Calacatta, Alabastro, Ardesia, matt Golden Calacatta, glänzend Golden Calacatta, matt Portoro, glänzend Portoro, glänzend Sahara Noir oder Keramik Brown Zinc.

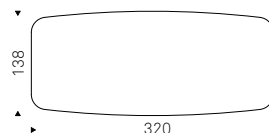
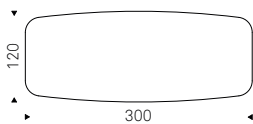
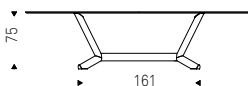
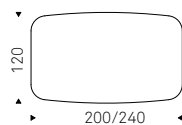
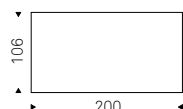
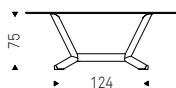
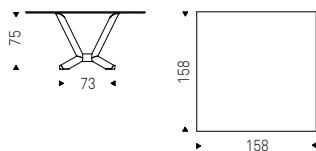

PLANER KERAMIK table with black base and Alabastro ceramic top



PLANER KERAMIK table with black base and glossy Portoro ceramic top - MAGDA COUTURE armchairs in soft leather 956 Atlantico and burned oak frame  
LANCELOT lamp - ROYALTON sideboard in titanium



PLANER KERAMIK table with black base and glossy Portoro ceramic top - MAGDA COUTURE armchairs in soft leather 956 Atlantico and burned oak frame  
LANCELOT lamp - ROYALTON sideboard in titanium - SABA showcase in 984 Bronzo



## SKYLINE WOOD

### Design Brogliato & Traverso

Tavolo con base in acciaio verniciato gofrato titanio, graphite o nero. Versione "A": piano con bordi obliqui in legno noce Canaletto, rovere Heritage o rovere naturale. Versione "B": piano a botte con bordi bisellati in noce Canaletto o rovere bruciato. Versione "C": piano in noce Canaletto con profilo inferiore arrotondato verniciato nero o Olmo tinto poro aperto nero opaco con profilo inferiore arrotondato verniciato Brushed Bronze.

Table with base in titanium, graphite or black embossed lacquered steel. Version "A": top with angled edges in Canaletto walnut, Heritage oak or natural oak. Version "B": barrel top with angled edges in Canaletto walnut or burned oak. Version "C": top in Canaletto walnut with black lacquered and rounded lower profile or open pore matt black Elm with Brushed Bronze lacquered and rounded lower profile.

Table avec base en acier gaufré titane, graphite ou noir. Version "A": plateau avec bords biseauté en bois noyer Canaletto, rouvre Heritage ou rouvre naturel. Version "B": plateau avec bords biseautés en noyer Canaletto ou rouvre brûlé. Version "C": plateau en noyer Canaletto avec profil inférieur arrondi laqué noire ou Orme laqué noir opaque pore ouvert avec profil inférieur arrondi laqué Brushed Bronze.

Mesa con base en acero barnizado gofrado titanio, graphite o negro. Versión "A": sobre con bordes oblicuos en nogal Canaletto, roble Heritage o roble natural. Versión "B": sobre con bordes biselados en nogal Canaletto o roble ahumado. Versión "C": sobre en nogal Canaletto y perfil inferior redondeado barnizado negro o Olmo barnizado negro mate a poro abierto y perfil inferior redondeado barnizado Brushed Bronze.

Esstisch mit Basis aus Stahl lackiert Titan, graphite oder schwarz gaufriert. Version "A": platte mit schrägen Kanten in Nussbaum Canaletto, Eiche Heritage oder Natur Eiche. Version "B": Platte mit schrägen Kanten aus Nussbaum Canaletto oder "verbrannte Eiche". Version "C": Platte aus Nussbaum Canaletto mit schwarz lackierten abgerundeten Profil oder Ulme offenporig lackiert schwarz matt mit Brushed Bronze lackierten abgerundeten Profil.

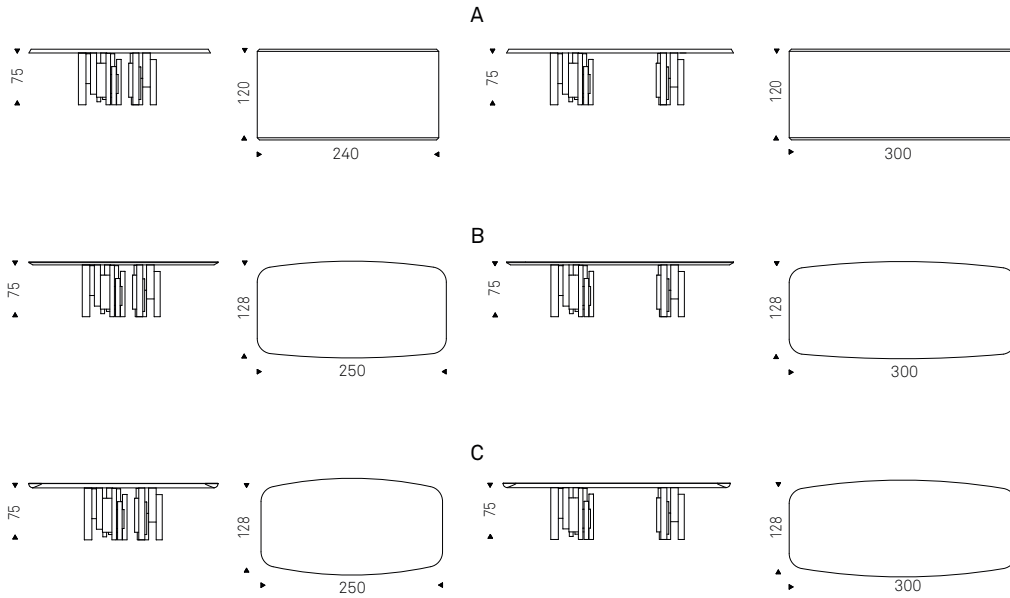









SKYLINE WOOD table with titanium base and "B" version top in burned oak - WANDA chair in 973 Nero soft leather - SUNSET lamp - MUMBAI rugs  
EUROPA KERAMIK sideboard in glossy Portoro ceramic - TRESOR shelf with black frame and bronze mirror

## SKYLINE KERAMIK

### Design Brogliato & Traverso

Tavolo con base in acciaio verniciato gofrato titanio, graphite o nero. Piano in ceramica Marmi nei colori Calacatta, Alabastro, Ardesia, Golden Calacatta opaco, Golden Calacatta lucido, Portoro opaco, Portoro lucido, Sahara Noir lucido o ceramica Brown Zinc.

Table with base in titanium, graphite or black embossed lacquered steel. Top in ceramic Marmi Calacatta, Alabastro, Ardesia, matt Golden Calacatta, glossy Golden Calacatta, matt Portoro, glossy Portoro, glossy Sahara Noir or Brown Zinc.

Table avec base en acier gaufré titane, graphite ou noir. Plateau en céramique Marmi dans les couleurs Calacatta, Alabastro, Ardesia, Golden Calacatta opaque, Golden Calacatta brillant, Portoro opaque, Portoro brillant, Sahara Noir brillant ou Brown Zinc.

Mesa con base en acero barnizado gofrado titanio, graphite o negro. Sobre en cerámica Marmi colores Calacatta, Alabastro, Ardesia, Golden Calacatta mate, Golden Calacatta brillo, Portoro mate, Portoro brillo, Sahara Noir brillo o cerámica Brown Zinc.

Esstisch mit Basis aus Metall lackiert Titan, graphite oder schwarz gaufriert. Platte in Keramik Marmi in den Farben Calacatta, Alabastro, Ardesia, matt Golden Calacatta, glänzend Golden Calacatta, matt Portoro, glänzend Portoro, glänzend Sahara Noir oder Keramik Brown Zinc.

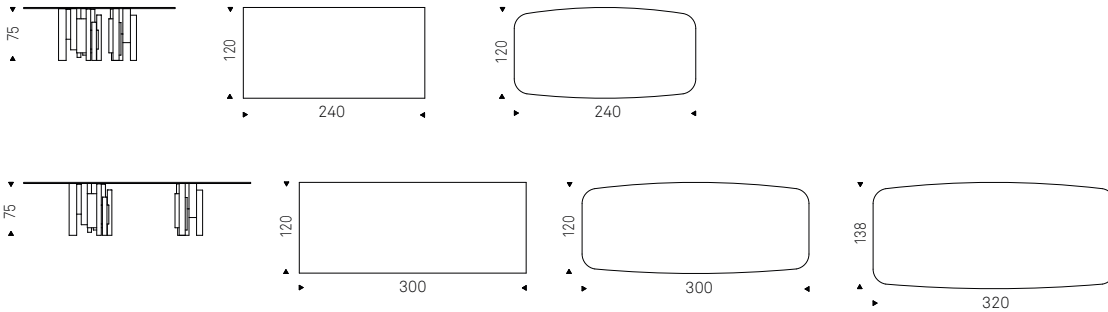

SKYLINE KERAMIK table with titanium base and Alabastro ceramic top



## SKYLINE

### Design Brogliato & Traverso

Tavolo con base in acciaio verniciato gofrato titanio, graphite o nero. Piano in cristallo specchiato bronzo o specchiato fumè. Piano in appoggio.

Table with base in titanium, graphite or black embossed lacquered steel. Top in bronze mirrored glass or fumè mirrored glass. The top is laid on the base.

Table avec base en acier gaufré titane, graphite ou noir. Plateau en verre miroité bronze ou miroité fumé. Plateau d'appui.

Mesa con base en acero barnizado gofrado titanio, graphite o negro. Sobre en cristal reflejado bronce o reflejado fumé. Sobre en apoyo.

Esstisch mit Basis aus Metall lackiert Titan, graphite oder schwarz gaufriert. Platte in Glas verspiegelt Bronze oder verspiegelt fumé. Platte auf die Basis gelegt.

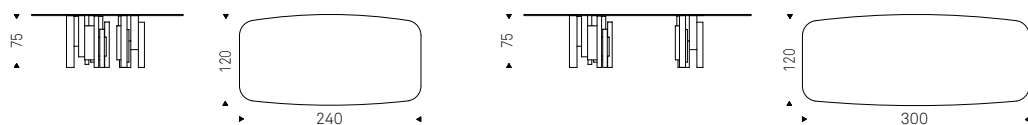

SKYLINE table with titanium base and fumè mirrored glass top



## SKORPIO

### Design **Andrea Lucatello**

Tavolo con base in acciaio verniciato trasparente, gofrato titanio, bianco, nero o graphite o Brushed Bronze. Piano in cristallo 15mm trasparente, trasparente extrachiaro o trasparente extrachiaro con bordi bisellati inversi. I piani 182x90 e 200x106 hanno spessore 12mm. Piano in appoggio.

Table with transparent varnished metal base, titanium, white, black, or graphite embossed lacquered steel or Brushed Bronze lacquered steel. Top in 15mm clear, extra clear or extra clear glass with reversed bevelled edges. Glass top 12mm on 182x90 and 200x106 versions. The top is laid on the base.

Table avec base en acier laqué transparent, gaufré titane, blanc, noir ou graphite ou Brushed Bronze. Plateau en verre clair 15 mm, extra-clair ou extra-clair avec bords biseautés inversés. Les plateaux 182x90 et 200x106 sont de 12mm. Plateau d'appui.

Mesa con base en acero barnizado transparente, gofrado titanio, blanco, negro o graphite o Brushed Bronze. Sobre en cristal 15mm transparente, transparente extraclaro o transparente extraclaro con bordes biselados inversos. Los sobres 182x90cm y 200x106cm son de 12mm. Sobre en apoyo.

Esstisch mit Basis aus Metall lackiert transparent oder Titan, weiß, schwarz oder graphite gaufriert oder Brushed Bronze. Platte in 15mm Glas transparent, extra hell transparent, oder extra hell mit Kanten umgekehrt facettiert. Platten in 182x90 und 200x106 haben 12 mm Dicke. Platte auf die Basis gelegt.

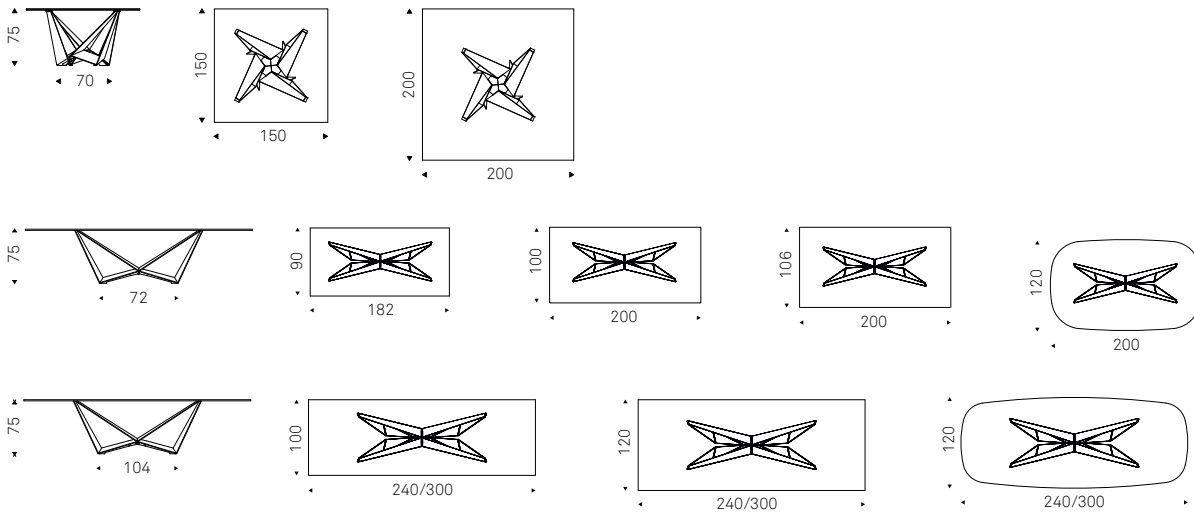





SKORPIO table with bronze base and extra clear glass top - ARCADIA H chairs with seat in soft leather 983 Argilla and wengé frame  
APOLLO 8R lamps - TIFFANY sideboard in soft leather 944 Bordeaux





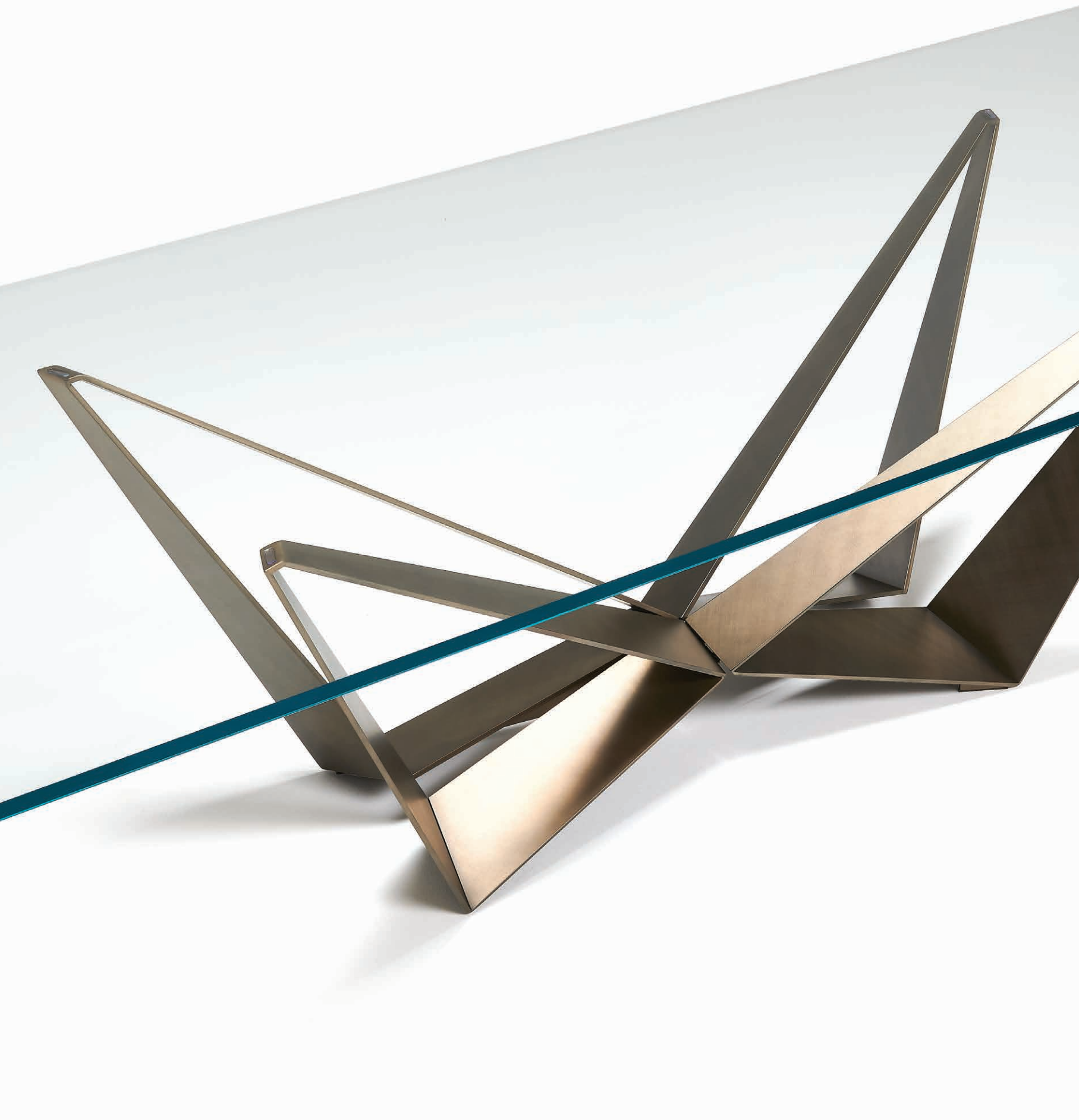



## SKORPIO KERAMIK

Design **A. Lucatello P. Cattelan**

Tavolo con base in acciaio verniciato trasparente, goffrato titanio, bianco, nero o graphite o Brushed Bronze. Piano in ceramica Marmi nei colori Calacatta, Alabastro, Ardesia, Golden Calacatta opaco, Golden Calacatta lucido, Portoro opaco, Portoro lucido, Sahara Noir lucido o ceramica Brown Zinc.

Table with transparent varnished metal base, titanium, white, black, or graphite embossed lacquered steel or Brushed Bronze. Top in ceramic Marmi Calacatta, Alabastro, Ardesia, matt Golden Calacatta, glossy Golden Calacatta, matt Portoro, glossy Portoro, glossy Sahara Noir or Brown Zinc.

Table avec base en acier laqué transparent, gauffré titane, blanc, noir ou graphite ou Brushed Bronze. Plateau en céramique Marmi dans les couleurs Calacatta, Alabastro, Ardesia, Golden Calacatta opaque, Golden Calacatta brillante, Portoro opaque, Portoro brillant, Sahara Noir brillant ou Brown Zinc.

Mesa con base en acero barnizado transparente, gofrado titanio, blanco, negro o graphite o Brushed Bronze. Sobre en cerámica Marmi colores Calacatta, Alabastro, Ardesia, Golden Calacatta mate, Golden Calacatta brillo, Portoro mate, Portoro brillo, Sahara Noir brillo o cerámica Brown Zinc.

Esstisch mit Basis aus Metall lackiert transparent oder Titan, weiß, schwarz oder graphite gaufriert oder Brushed Bronze. Platte in Keramik Marmi in den Farben Calacatta, Alabastro, Ardesia, matt Golden Calacatta, glänzend Golden Calacatta, matt Portoro, glänzend Portoro, glänzend Sahara Noir oder Keramik Brown Zinc.

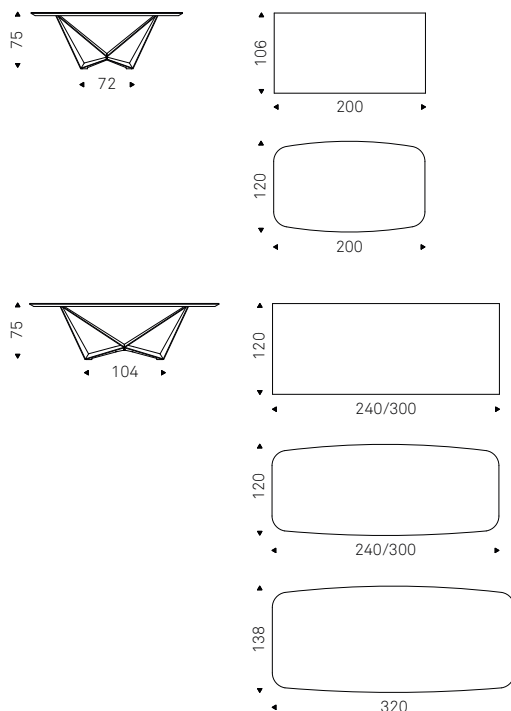



SKORPIO KERAMIK table with black base and Sahara Noir ceramic top - KELLY chair in soft leather 953 Ardesia and black frame - LANCELOT lamp  
ABSOLUT sideboard in soft leather 987 Sherwood and graphite frame - MAMBA lamp in Brushed Bronze - EMERALD in fume mirror



SKORPIO KERAMIK table with black base and Sahara Noir ceramic top - KELLY chair in soft leather 953 Ardesia and black frame - LANCELOT lamp  
ABSOLUT sideboard in soft leather 987 Sherwood and graphite frame - MAMBA lamp in Brushed Bronze - EMERALD in tume mirror





SKORPIO WOOD table with Brushed Bronze base and "C" version top in matt black Elm with Brushed Bronze profile



**SKORPIO WOOD - C****Design****A. Lucatello P. Cattelan**

Tavolo con base in acciaio verniciato trasparente, gofrato titanio, bianco, nero o graphite o Brushed Bronze. Versione "C": piano in noce Canaletto con profilo inferiore arrotondato e verniciato nero o Olmo tinto poro aperto nero opaco con profilo inferiore arrotondato verniciato Brushed Bronze.

Table with transparent varnished metal base, titanium, white, black, or graphite embossed lacquered steel or Brushed Bronze lacquered steel. Version "C": top in Canaletto walnut with black lacquered and rounded lower profile or open pore matt black Elm with Brushed Bronze lacquered and rounded lower profile.

Table avec base en acier laqué transparent, gaufré titane, blanc, noir ou graphite ou Brushed Bronze. Version "C": plateau en noyer Canaletto avec profil inférieur arrondi laqué noire ou Orme laqué noir opaque pore ouvert avec profil inférieur arrondi laqué Brushed Bronze.

Mesa con base en acero barnizado transparente, gofrado titanio, blanco, negro o graphite o Brushed Bronze. Versión "C": sobre en nogal Canaletto y perfil inferior redondeado barnizado negro o Olmo barnizado negro mate a poro abierto y perfil inferior redondeado barnizado Brushed Bronze.

Esstisch mit Basis aus Metall lackiert transparent oder Titan, weiß, schwarz oder graphite gaufriert oder Brushed Bronze. Version "C": Platte aus Nussbaum Canaletto mit schwarz lackierten abgerundeten Profil oder Ulme offenporig lackiert schwarz matt mit Brushed Bronze lackierten abgerundeten Profil.

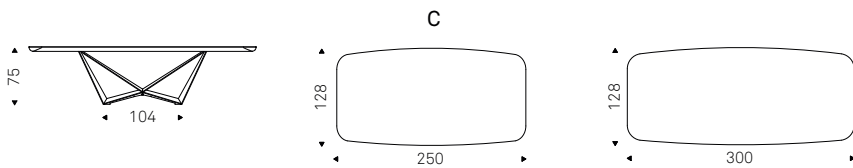

## GORDON OUTDOOR

### Design **Giorgio Cattelan**

Tavolo da esterno con base in acciaio verniciato gofrato titanio, bianco o graphite. Piano in ceramica 12mm nel colore Golden Calacatta opaco.

Outdoor table with titanium, white or graphite embossed lacquered steel base. 12mm ceramic top in matt Golden Calacatta.

Table d'extérieur avec base en acier laqué gaufré titane, blanc ou graphite. Plateau en céramique 12mm dans la couleur Golden Calacatta opaque.

Mesa apta para uso exterior con base en acero barnizado gofrado titanio, blanco o graphite. Sobre en cerámica 12mm color Golden Calacatta mate.

Esstisch für den Außenbereich mit Basis aus Stahl lackiert Titan, weiß oder graphite gaufriert. Platte in Keramik 12mm Golden Calacatta matt.

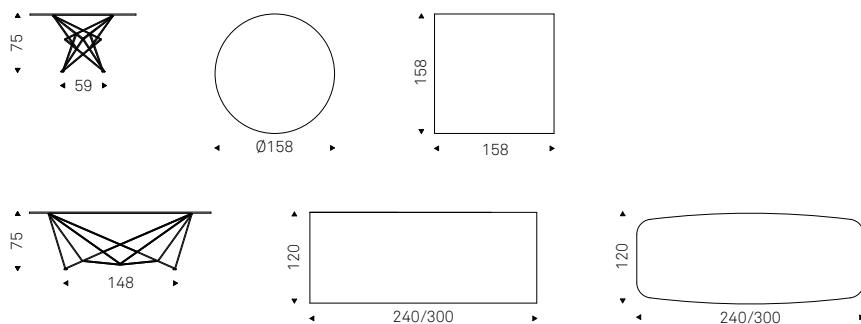

GORDON OUTDOOR table top with titanium base and matt Golden Calacatta ceramic top



## SKORPIO ROUND KER-WOOD

Design **P. Cattelan - A. Lucatello**

Tavolo con base in acciaio gofrato bianco, nero o graphite o Brushed Bronze. Piano in legno noce Canaletto o rovere bruciato e inserto in ceramica Marmi nei colori Calacatta, Alabastro, Ardesia, Golden Calacatta opaco, Golden Calacatta lucido, Portoro opaco, Portoro lucido, Sahara Noir lucido o ceramica Brown Zinc. Inserti in cromo nero.

Table with base in white, black or graphite embossed lacquered steel or Brushed Bronze. Top in Canaletto walnut or burned oak with insert in ceramic Marmi Calacatta, Alabastro, Ardesia, matt Golden Calacatta, glossy Golden Calacatta, matt Portoro, glossy Portoro, glossy Sahara Noir or Brown Zinc. Black chrome inserts.

Table avec base en acier gaufré blanc, noir ou graphite ou Brushed Bronze. Plateau en noyer Canaletto ou rouvre brulé et insert en céramique Marmi dans les couleurs Calacatta, Alabastro, Ardesia, Golden Calacatta opaque, Golden Calacatta brillant, Portoro opaque, Portoro brillant, Sahara Noir brillant ou Brown Zinc. Inserts en chrome noir.

Mesa con base en acero gofrado blanco, negro o graphite o Brushed Bronze. Sobre en madera nogal Canaletto o roble ahumado con detalle en cerámica Marmi colores Calacatta, Alabastro, Ardesia, Golden Calacatta mate, Golden Calacatta brillo, Portoro mate, Portoro brillo, Sahara Noir brillo o cerámica Brown Zinc. Detalles en cromo negro.

Esstisch mit Basis aus Metall lackiert weiß, schwarz oder graphite gaufriert oder Brushed Bronze. Platte in Nussbaum Canaletto oder "verbrannte Eiche". Keramik Marmi Einsetze in den Farben Calacatta, Alabastro, Ardesia, matt Golden Calacatta, glänzend Golden Calacatta, matt Portoro, glänzend Portoro, glänzend Sahara Noir oder Keramik Brown Zinc. Einsetze in schwarz Chrome.

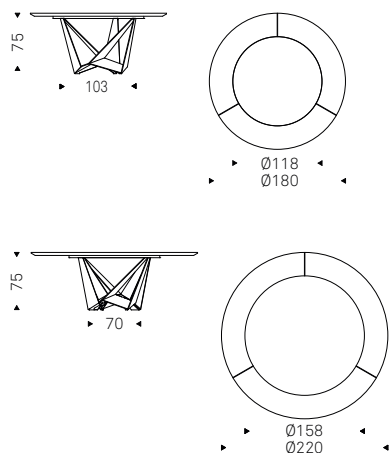





SKORPIO KER-WOOD table with black base and matt Portoro ceramic and burned oak top  
 MAGDA COUTURE chairs in 948 Lino soft leather and burned oak frame - APOLLO lamp - HARLEM bookcase in bronze  
 ASTON sideboard with black frame and doors in soft leather 948 Lino and burned oak - WISH mirror in Brushed Bronze.





SOHO ROUND KERAMIK table with black base and matt Portoro ceramic top - MAGDA COUTURE chairs in soft leather 948 Lino and burned oak frame  
TWISTER lamp in titanium finish - ROYALTON sideboard in titanium - MUMBAI rug



**SOHO KERAMIK****Design Brogliato & Traverso**

Tavolo con base in acciaio verniciato gofrato titanio, graphite o nero. Piano in ceramica Marmi nei colori Calacatta, Alabastro, Ardesia, Golden Calacatta opaco, Golden Calacatta lucido, Portoro opaco o Portoro lucido.

Table with base in titanium, graphite or black embossed lacquered steel. Top in ceramic Marmi Calacatta, Alabastro, Ardesia, matt Golden Calacatta, glossy Golden Calacatta, matt Portoro or glossy Portoro.

Table avec base en acier gaufré titane, graphite ou noir. Plateau en céramique Marmi dans les couleurs Calacatta, Alabastro, Ardesia, Golden Calacatta opaque, Golden Calacatta brillant, Portoro opaque ou Portoro brillant.

Mesa con base en acero barnizado gofrado titanio, graphite o negro. Sobre en cerámica Marmi colores Calacatta, Alabastro, Ardesia, Golden Calacatta mate, Golden Calacatta brillo, Portoro mate o Portoro brillo.

Esstisch mit Basis aus Metall lackiert Titan, graphite oder schwarz gaufriert. Platte in Keramik Marmi in den Farben Calacatta, Alabastro, Ardesia, matt Golden Calacatta, glänzend Golden Calacatta, matt Portoro oder glänzend Portoro.

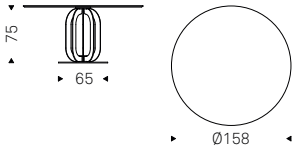





## SOHO KER-WOOD

Design **Brogliato & Traverso**  
**P. Cattelan**

Tavolo con base in acciaio verniciato gofrato titanio, graphite o nero. Piano in legno noce Canaletto o rovere bruciato e inserto in ceramica Marmi nei colori Calacatta, Alabastro, Ardesia, Golden Calacatta opaco, Golden Calacatta lucido o Sahara Noir lucido. Inserti in cromo nero.

Table with base in titanium, graphite or black embossed lacquered steel. Top in Canaletto walnut or burned oak with insert in ceramic Marmi Calacatta, Alabastro, Ardesia, matt Golden Calacatta, glossy Golden Calacatta or glossy Sahara Noir. Black chrome inserts.

Table avec base en acier gaufré titane, graphite ou noir. Plateau en noyer Canaletto ou rouvre brûlé et insert en céramique Marmi dans les couleurs Calacatta, Alabastro, Ardesia, Golden Calacatta opaque, Golden Calacatta brillant ou Sahara Noir brillant. Insert en chrome noir.

Mesa con base en acero barnizado gofrado titanio, graphite o negro. Sobre en madera nogal Canaletto o roble ahumado con detalle en cerámica Marmi colores Calacatta, Alabastro, Ardesia, Golden Calacatta mate, Golden Calacatta brillo o Sahara Noir brillo. Detalle en cromo negro.

Esstisch mit Basis aus Metall lackiert Titan, graphite oder schwarz gaufriert. Platte in Nussbaum Canaletto oder "verbrannte Eiche". Keramik Marmi Einsetze in den Farben Calacatta, Alabastro, Ardesia, matt Golden Calacatta, glänzend Golden Calacatta oder glänzend Sahara Noir. Einsetze in schwarz Chrome.

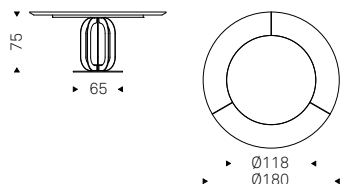

SOHO ROUND KER-WOOD table with black base and Alabastro ceramic and walnut Canaletto top







SOHO ROUND KER-WOOD table with black base and Alabastro ceramic and walnut Canaletto top - BELINDA chairs in soft leather 973 Nero and burned oak frame  
POSEIDON Z4 lamp in black finish - PADUA rug - ARIZONA sideboard - PINKO in soft leather 951 Castoro - AIRPORT bookcase with Brushed Bronze shelves and black frame









PLANER ROUND table with black base and bronze mirrored top - DIANA chairs in soft leather 951 Castoro - KAYAK sideboard in titanium  
STEALTH lamp in black finish - TRESOR shelf with black frame and bronze mirror

**PLANER ROUND****Design Paolo Cattelan**

Tavolo con base in acciaio verniciato gofrato titanio, graphite o nero o Brushed Bronze. Piano in cristallo trasparente o trasparente extrachiaro con bordo bisellato 15mm o in cristallo specchiato bronzo o specchiato fumè. Piano in appoggio.

Table with base in titanium, graphite or black embossed lacquered steel or Brushed Bronze. 15 mm top in clear or extra clear glass with bevelled edges, bronze mirrored or fumé mirrored glass. The top is laid on the base.

Table avec base en acier gaufré titane, graphite ou noir ou Brushed Bronze. Plateau en verre clair ou extra-clair 15 mm avec bord biseauté ou en verre miroité bronze ou miroité fumé. Plateau d'appui.

Mesa con base en acero barnizado gofrado titanio, graphite o negro o Brushed Bronze. Sobre en cristal transparente o transparente extraclaro con borde biselado 15mm o en cristal reflejado bronze o reflejado fumé. Sobre en apoyo.

Esstisch mit Basis aus Stahl lackiert Titan, graphite oder schwarz gaufriert, oder Brushed Bronze. Platte in Glas transparent oder Glas extra hell transparent mit schrägen Kanten 15 mm Dick oder aus Glas verspiegelt bronze oder verspiegelt fumé. Platte auf die Basis gelegt.

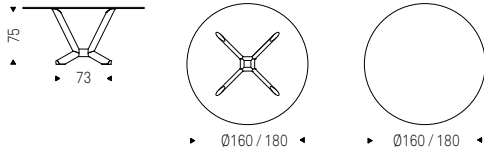

## PLANER ROUND KER-WOOD

Design **Paolo Cattelan**

Tavolo con base in acciaio verniciato gofrato titanio, graphite o nero o Brushed Bronze. Piano in legno noce Canaletto o rovere bruciato e inserto in ceramica Marmi nei colori Calacatta, Alabastro, Ardesia, Golden Calacatta opaco, Golden Calacatta lucido, Portoro opaco, Portoro lucido, Sahara Noir lucido o ceramica Brown Zinc. Inserti in cromo nero.

Table with base in titanium, graphite or black embossed lacquered steel or Brushed Bronze. Top in Canaletto walnut or burned oak with insert in ceramic Marmi Calacatta, Alabastro, Ardesia, matt Golden Calacatta, glossy Golden Calacatta, matt Portoro, glossy Portoro, glossy Sahara Noir or Brown Zinc. Black chrome inserts.

Table avec base en acier gaufré titane, graphite ou noir ou Brushed Bronze. Plateau en noyer Canaletto ou rouvre brulé et insert en céramique Marmi dans les couleurs Calacatta, Alabastro, Ardesia, Golden Calacatta opaque, Golden Calacatta brillante, Portoro opaque, Portoro brillant, Sahara Noir brillant ou Brown Zinc. Inserts en chrome noir.

Mesa con base en acero barnizado gofrado titanio, graphite o negro o Brushed Bronze. Sobre en madera nogal Canaletto o roble ahumado con detalle en cerámica Marmi colores Calacatta, Alabastro, Ardesia, Golden Calacatta mate, Golden Calacatta brillo, Portoro mate, Portoro brillo, Sahara Noir brillo o cerámica Brown Zinc. Detalles en cromo negro.

Esstisch mit Basis aus Stahl lackiert Titan, graphite oder schwarz gaufriert oder Brushed Bronze. Platte in Nussbaum Canaletto oder "verbrannte Eiche". Keramik Marmi Einsetze in den Farben Calacatta, Alabastro, Ardesia, matt Golden Calacatta, glänzend Golden Calacatta, matt Portoro, glänzend Portoro, glänzend Sahara Noir oder Keramik Brown Zinc. Einsetze in schwarz Chrome.

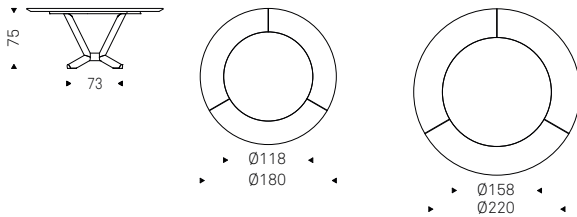



PLANER KER-WOOD table with black base and Alabastro ceramic and walnut Canaletto top

## PLANER ROUND KERAMIK

Design Paolo Cattelan

Tavolo con base in acciaio verniciato goffrato titanio, graphite o nero o Brushed Bronze. Piano in ceramica Marmi nei colori Calacatta, Alabastro, Ardesia, Golden Calacatta opaco, Golden Calacatta lucido, Portoro opaco o Portoro lucido.

Table with base in titanium, graphite or black embossed lacquered steel or Brushed Bronze. Top in ceramic Marmi Calacatta, Alabastro, Ardesia, matt Golden Calacatta, glossy Golden Calacatta, matt Portoro or glossy Portoro.

Table avec base en acier gaufré titane, graphite ou noir ou Brushed Bronze. Plateau en céramique Marmi dans les couleurs Calacatta, Alabastro, Ardesia, Golden Calacatta opaque, Golden Calacatta brillant, Portoro opaque ou Portoro brillant.

Mesa con base en acero barnizado gofrado titanio, graphite o negro o Brushed Bronze. Sobre en cerámica Marmi colores Calacatta, Alabastro, Ardesia, Golden Calacatta mate, Golden Calacatta brillo, Portoro mate o Portoro brillo.

Esstisch mit Basis aus Stahl lackiert Titan, graphite oder schwarz gaufriert oder Brushed Bronze. Platte in Keramik Marmi in den Farben Calacatta, Alabastro, Ardesia, matt Golden Calacatta, glänzend Golden Calacatta, matt Portoro oder glänzend Portoro.

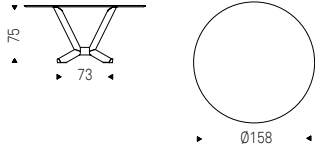



PLANER ROUND KERAMIK table with black base and matt Golden Calacatta ceramic top - BELINDA chair in soft leather 948 Lino - BYBLOS lamp in black finish

## SKYLINE ROUND KERAMIK

### Design Brogliato & Traverso

Tavolo con base in acciaio verniciato gofrato titanio, graphite o nero. Piano in ceramica Marmi nei colori Calacatta, Alabastro, Ardesia, Golden Calacatta opaco, Golden Calacatta lucido, Portoro opaco o Portoro lucido.

Table with base in titanium, graphite or black embossed lacquered steel. Top in ceramic Marmi Calacatta, Alabastro, Ardesia, matt Golden Calacatta, glossy Golden Calacatta, matt Portoro or glossy Portoro.

Table avec base en acier gaufré titane, graphite ou noir. Plateau en céramique Marmi dans les couleurs Calacatta, Alabastro, Ardesia, Golden Calacatta opaque, Golden Calacatta brillant, Portoro opaque ou Portoro brillant.

Mesa con base en acero barnizado gofrado titanio, graphite o negro. Sobre en cerámica Marmi colores Calacatta, Alabastro, Ardesia, Golden Calacatta mate, Golden Calacatta brillo, Portoro mate o Portoro brillo.

Esstisch mit Basis aus Metall lackiert Titan, graphite oder schwarz gaufriert. Platte in Keramik Marmi in den Farben Calacatta, Alabastro, Ardesia, matt Golden Calacatta, glänzend Golden Calacatta, matt Portoro oder glänzend Portoro.

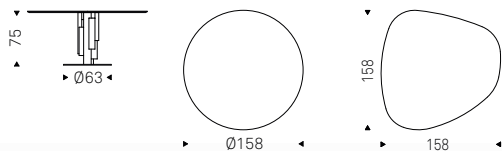





SKYLINE ROUND KERAMIK table with titanium base and matt Portoro ceramic top





## LINUS WOOD

### Design Alberto Danese

Tavolo con base e colonna in acciaio verniciato gofrato titanio, graphite, nero o base gofrato nero e colonna in cromo nero. Piano in legno noce Canaletto o rovere bruciato.

Table with titanium, graphite or black embossed steel base and column or with black embossed steel base and black chrome steel column. Top in Canaletto walnut or burned oak.

Table avec base et pied en acier gaufré titane, graphite, noir ou avec base en acier gaufré noir et pied en acier chromé noir. Plateau en noyer Canaletto ou rouvre brulé.

Mesa con base y columna en acero barnizado gofrado titanio, graphite, negro o con base en acero barnizado gofrado negro y columna en cromo negro. Sobre en madera nogal Canaletto o roble ahumado.

Esstisch mit Basis und Säule aus Stahl lackiert titan, graphit, schwarz gaufriert oder mit Basis aus Stahl lackiert schwarz gaufriert und Säule aus Stahl schwarz Chrom. Platte in Nussbaum Canaletto oder "verbrannte Eiche".

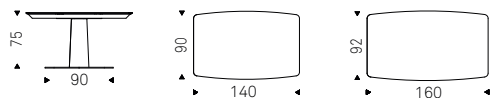



## LINUS WOOD DRIVE

Design **Alberto Danese**

Tavolo allungabile con colonna e base in acciaio verniciato gofrato titanio, graphite, nero o colonna in cromo nero e base gofrato nero. Vano porta prolunghe verniciato gofrato nero. Piano e prolunghe in legno noce Canaletto o rovere bruciato.

Extendible table with titanium, graphite or black embossed steel column and base or with black chrome steel column and black embossed steel base. Extension compartment in black embossed steel. Top and extensions in Canaletto walnut or burned oak.

Table à rallonges avec base et pied en acier gaufré titane, graphite, noir ou avec base en acier gaufré noir et pied en acier chromé noir. Compartiment d'extension gaufré noir. Plateau et rallonges en noyer Canaletto ou rouvre brûlé.

Mesa extensible con base y columna en acero barnizado gofrado titanio, graphite, negro o con base en acero barnizado gofrado negro y columna en cromo negro. Compartimiento para extensiones barnizado gofrado negro. Sobre y extensiones en madera nogal Canaletto o roble ahumado.

Ausziehbarer Esstisch mit Basis und Säule aus Stahl lackiert titan, graphit, schwarz gaufriert oder mit Basis aus Stahl lackiert schwarz gaufriert und Säule aus Stahl schwarz Chrom. Platte und Verlängerungen aus Nussbaum Canaletto oder "verbrannte Eiche".

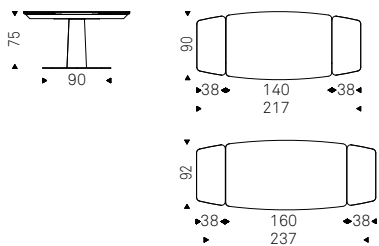



LINUS WOOD DRIVE table with black chrome base and burned oak top - KAY COUTURE in soft leather 956 Atlantico - ARIZONA sideboard  
TRESOR shelves with black frame and bronze mirror - TWISTER lamps in black chrome







## LINUS KERAMIK DRIVE

Design **Alberto Danese**

Tavolo allungabile con colonna e base in acciaio verniciato gofrato titanio, graphite, nero o colonna in cromo nero e base gofrata nero. Piano in ceramica Marmi nei colori Calacatta, Alabastro, Ardesia, Golden Calacatta opaco, Golden Calacatta lucido, Portoro opaco, Portoro lucido o Sahara Noir lucido.

Extendible table with titanium, graphite or black embossed steel column and base or with black chrome steel column and black embossed steel base. Marmi ceramic top in Calacatta, Alabastro, Ardesia, matt Golden Calacatta, glossy Golden Calacatta, matt Portoro, glossy Portoro or glossy Sahara Noir.

Table à rallonges avec base et pied en acier gaufré titane, graphite, noir ou avec base en acier chromé noir et pied en acier chromé noir. Plateau en céramique Marmi dans les couleurs Calacatta, Alabastro, Ardesia, Golden Calacatta opaque, Golden Calacatta brillant, Portoro opaque, Portoro brillant ou Sahara Noir brillant.

Mesa extensible con base y columna en acero barnizado gofrado titanio, graphite, negro o con base en acero barnizado gofrado negro y columna en cromo negro. Sobre en cerámica Marmi colores Calacatta, Alabastro, Ardesia, Golden Calacatta mate, Golden Calacatta brillo, Portoro mate, Portoro brillo o Sahara Noir brillo.

Ausziehbarer Esstisch mit Basis und Säule aus Stahl lackiert titan, graphit, schwarz gaufriert oder mit Basis aus Stahl lackiert schwarz gaufriert und Säule aus Stahl schwarz Chrom. Platte in Keramik Marmi in den Farben Calacatta, Alabastro, Ardesia, matt Golden Calacatta, glänzend Golden Calacatta, matt Portoro, glänzend Portoro oder glänzend Sahara Noir.





LINUS KERAMIK DRIVE table with titanium base and polished Golden Calacatta ceramic top

## DUFFY WOOD

### Design Alberto Danese

Tavolo con base e colonna in acciaio verniciato gofrato titanio, graphite o nero. Piano in legno noce Canaletto o rovere bruciato.

Table with titanium, graphite or black embossed steel base and column. Top in Canaletto walnut or burned oak.

Table avec base et pied en acier gaufré titane, graphite ou noir. Plateau en noyer Canaletto ou rouvre brulé.

Mesa con base y columna en acero barnizado gofrado titanio, graphite o negro. Sobre en madera nogal Canaletto o roble ahumado.

Esstisch mit Basis und Säule aus Stahl lackiert titan, graphit oder schwarz gaufriert. Platte in Nussbaum Canaletto oder "verbrannte Eiche".

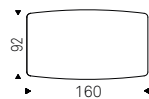
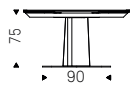



DUFFY WOOD table with titanium base and burned oak wooden top

## DUFFY KERAMIK DRIVE

Design **Alberto Danese**

Tavolo allungabile con base e colonna in acciaio verniciato gofrato titanio, graphite o nero. Piano in ceramica Marmi nei colori Calacatta, Alabastro, Ardesia, Golden Calacatta opaco, Golden Calacatta lucido, Portoro opaco, Portoro lucido o Sahara Noir lucido.

Extendible table with titanium, graphite or black embossed steel base and column. Marmi ceramic top in Calacatta, Alabastro, Ardesia, matt Golden Calacatta, glossy Golden Calacatta, matt Portoro, glossy Portoro or glossy Sahara Noir.

Table à rallonges avec base et pied en acier gaufré titane, graphite ou noir. Plateau en céramique Marmi dans les couleurs Calacatta, Alabastro, Ardesia, Golden Calacatta opaque, Golden Calacatta brillante, Portoro opaque, Portoro brillant ou Sahara Noir brillant.

Mesa extensible con base y columna en acero barnizado gofrado titanio, graphite o negro. Sobre en cerámica Marmi colores Calacatta, Alabastro, Ardesia, Golden Calacatta mate, Golden Calacatta brillo, Portoro mate, Portoro brillo o Sahara Noir brillo.

Ausziehbarer Esstisch mit Basis und Säule aus Stahl lackiert titan, graphit oder schwarz gaufriert. Platte in Keramik Marmi in den Farben Calacatta, Alabastro, Ardesia, matt Golden Calacatta, glänzend Golden Calacatta, matt Portoro, glänzend Portoro oder glänzend Sahara Noir.

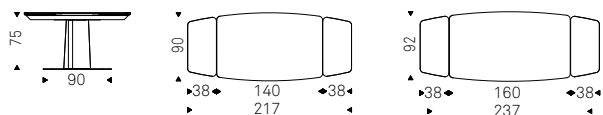

DUFFY KERAMIK DRIVE with titanium base and matt Portoro ceramic top



DUFFY KERAMIK DRIVE with titanium base and polished Golden Calacatta ceramic top - ARCADIA chairs in soft leather 948 Lino and burned oak frame - SUNSET lamp - MUMBAI rugs  
KAYAK sideboard in titanium finish - HAWAII "B" mirror in bronze finish







## DUFFY WOOD DRIVE

Design **Alberto Danese**

Tavolo allungabile con base e colonna in acciaio verniciato gofrato titanio, graphite o nero. Vano porta prolunghe verniciato gofrato nero. Piano e prolunghe in legno noce Canaletto o rovere bruciato.

Extendible table with titanium, graphite or black embossed steel base and column. Extension compartment in black embossed steel. Top and extensions in Canaletto walnut or burned oak.

Table à rallonges avec base et pied en acier gaufré titane, graphite ou noir. Compartiment d'extension gaufré noir. Plateau et rallonges en noyer Canaletto ou rouvre brûlé.

Mesa extensible con base y columna en acero barnizado gofrado titanio, graphite o negro. Compartimiento para extensiones barnizado gofrado negro. Sobre y extensiones en madera nogal Canaletto o roble ahumado.

Ausziehbarer Esstisch mit Basis und Säule aus Stahl lackiert titan, graphit oder schwarz gaufriert. Platte und Verlängerungen aus Nussbaum Canaletto oder "verbrannte Eiche".

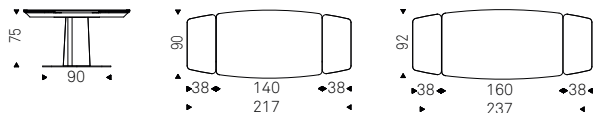

DUFFY WOOD DRIVE table with titanium base and burned oak wooden top



## CONVIVIUM

### Design Giorgio Cattelan

Consolle allungabile con base in acciaio verniciato goffrato titanio, bianco, graphite o inox satinato. Piano e prolunghe in laminato bianco climb, ossido grigio, noce, cemento, grigio Londra Fenix o castoro Ottawa Fenix. Inclusa borsa porta prolunghe.

Extendible console with base in titanium, white or graphite embossed lacquered steel or in satin stainless steel. Top and extensions in white climb, grey oxide, walnut, cement, grey London Fenix or castor Ottawa Fenix laminated wood. Bag for extensions included.

Console à rallonges avec base en acier gaufré titane, blanc, graphite ou inox satiné. Plateau et rallonges en laminé blanc climb, oxyde gris, noyer, ciment, gris Londres Fenix ou castor Ottawa Fenix. Porte rallonges compris.

Consola extensible con base en acero barnizado gofrado titanio, blanco, graphite o acero inox satinado. Sobre y extensiones en laminado blanco climb, óxido gris, nogal, cemento, gris Londres Fenix o castor Ottawa Fenix. Bolsa para extensiones incluida.

Konsole mit Verlängerungen, Basis in Stahl lackiert Titan, weiß oder graphite gaufriert oder in Edelstahl gebürstet. Platte und Verlängerungen aus Laminat in den Farben: weiß Climb, grau Oxid, Nussbaum, Zement, London grau Fenix oder Biber Ottawa Fenix. Tasche für Verlängerungen ist enthalten.

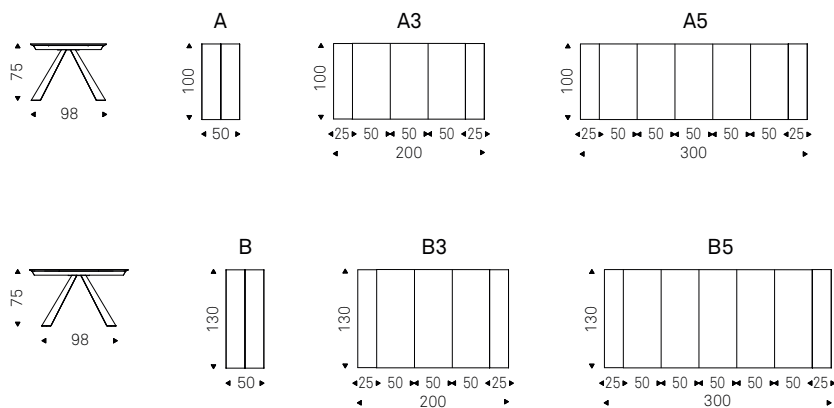



CONVIVIUM console with titanium base and white climb top - PINKO in soft leather 951 Castoro - FISHERMAN lamps in black finish













**WALL STREET****Design Alessio Bassan**

Scrivania in MDF laccato graphite o nero gofrato fine. Piano in ceramica Marmi nei colori Calacatta, Alabastro, Ardesia, Golden Calacatta opaco, Golden Calacatta lucido o Sahara Noir lucido.

Desk in graphite or black lacquered embossed MDF. Top in ceramic Marmi colors Calacatta, Alabastro, Ardesia, matt Golden Calacatta, glossy Golden Calacatta or glossy Sahara Noir.

Bureau en MDF gaufré graphite ou noir. Plateau en céramique Marmi dans les couleurs Calacatta, Alabastro, Ardesia, Golden Calacatta opaque, Golden Calacatta brillant ou Sahara Noir brillant.

Escritorio en MDF lacado gofrado graphite o negro. Sobre en cerámica Marmi colores Calacatta, Alabastro, Ardesia, Golden Calacatta mate, Golden Calacatta brillo o Sahara Noir brillo.

Schreibtisch aus graphite oder schwarz gaufriertem MDF. Platte in Keramik Marmi in den Farben Calacatta, Alabastro, Ardesia, matt Golden Calacatta, glänzend Golden Calacatta oder glänzend Sahara Noir.

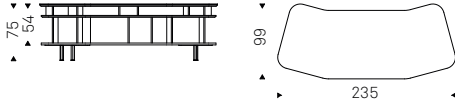



WALL STREET desk with black frame and matt Golden Calacatta ceramic top - TYLER WHEELS in soft leather 953 Ardesia and black frame  
STEALTH lamp in black finish - WALLY bookcase in bronze finish





MALIBÙ desk with black base and walnut Canaletto top - KELLY chair in soft leather 953 Ardesia and black frame

**MALIBÙ****Design Paolo Cattelan**

Scrivania con base in acciaio verniciato gofrato graphite o nero. Piano in noce Canaletto o rovere bruciato.

Desk with base in graphite or black embossed lacquered steel. Top in Canaletto walnut or burned oak.

Bureau avec base en acier gaufré graphite ou noir. Plateau en noyer Canaletto ou rouvre brûlé.

Escritorio con base en acero barnizado gofrado graphite o negro. Sobre en nogal Canaletto o roble ahumado.

Schreibtisch mit Basis in Stahl lackiert graphite oder schwarz gaufriert. Platte aus Nussbaum Canaletto oder "verbrannte Eiche".

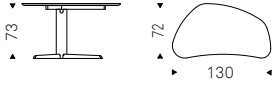









STORM desk in titanium with PAD in 53 Ardesia - PINKO pouf in soft leather 95 L Castoro - WALLY bookcase in bronze finish

**STORM****Design Andrea Lucatello**

Scrivania con struttura e piano in acciaio verniciato gofrato titanio, bianco o graphite. Pad in cuoio nei colori come da campionario.

Desk with frame and top in titanium, white or graphite embossed lacquered steel. Leather pad as per sample card.

Bureau avec structure et plateau en acier gaufré titane, blanc ou graphite. Sous-main en cuir selon échantillons.

Escritorio con estructura en acero barnizado gofrado titanio, blanco o graphite. Pad en cuero de color según muestrario.

Schreibtisch mit Basis und Platte aus Edelstahl lackiert Titan, weiß oder graphite gaufriert. Pad in Kernleder, Farbe laut Musterkarte.

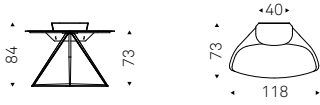





## WESTIN

### Design Giorgio Cattelan

Consolle con base in acciaio verniciato gofrato titanio, bianco, graphite, mix o Brushed Bronze. Piano in cristallo 12mm trasparente, trasparente extrachiaro o in legno noce Canaletto, rovere bruciato o rovere naturale con bordo irregolare in massello. Fissaggio a parete necessario.

Console with base in titanium, white, graphite or mix embossed lacquered steel or Brushed Bronze. 12mm top in clear, extra clear glass or Canaletto walnut, burned oak or natural oak with solid wood irregular edges. Wall anchorage is necessary.

Console avec base en acier gaufré, laqué titane, blanc, graphite, mix ou Brushed Bronze. Top en verre clair, transparent extra-clair 12mm ou en bois de noyer Canaletto, rouvre brûlé ou rouvre naturel avec bord irrégulier en massif. Fixation au mur nécessaire.

Consola con base en acero barnizado gofrado titanio, blanco, graphite, mix o Brushed Bronze. Sobre en cristal 12mm transparente, transparente extraclaro o de madera nogal Canaletto, roble ahumado o roble natural con bordes irregulares en macizo. Ajuste a la pared es necesario.

Konsole mit Basis in Stahl lackiert Titan, weiss, graphite gaufriert oder mix oder Brushed Bronze. Platte in transparentem oder extra hell Glas in 12mm oder aus Holz Nussbaum Canaletto, "verbrannte Eiche" oder Natur Eiche mit massiven Kanten. Wandbefestigung ist notwendig.

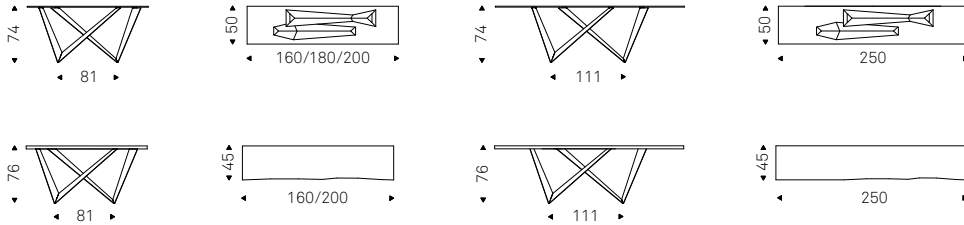



WESTIN CONSOLLE with Brushed Bronze base and burned oak top - HAWAII mirror in bronze finish - SUNSET lamps



SKYLINE CONSOLE with titanium base and burned oak top - EMERALD mirror in fumé finish - MUMBAI rug



**SKYLINE CONSOLLE****Design Brogliato & Traverso**

Consolle con base in acciaio verniciato gofrato titanio, graphite o nero. Piano in noce Canaletto, rovere bruciato o rovere naturale con bordo irregolare in massello. Fissaggio a parete necessario.

Console with base in titanium, graphite or black embossed lacquered steel. Top in Canaletto walnut, burned oak or natural oak with solid wood irregular edges. Wall anchorage is necessary.

Console avec base en acier gaufré titane, graphite ou noir. Plateau en noyer Canaletto, rouvre brulé ou rouvre naturel avec bord irrégulier en massif. Fixation au mur nécessaire.

Consola con base en acero barnizado gofrado titanio, graphite o negro. Sobre en nogal Canaletto, roble ahumado o roble natural con bordes irregulares en macizo. Ajuste a la pared necesario.

Konsole mit Basis aus Stahl lackiert Titan, graphite oder schwarz gaufriert. Platte in Nussbaum Canaletto, "verbrannte Eiche" oder Natur Eiche mit unregelmässigen Kanten aus massiv Holz. Wandbefestigung ist notwendig.



## KELLY

### Design Archirivolto

Sedia girevole con base a 4 razze in alluminio verniciato gofrato graphite, bianco o nero. Seduta e schienale rivestiti in tessuto, synthetic nubuck, ecopelle o pelle come da campionario.

Swiveling chair with 4 spokes base in graphite, white or black embossed laquered aluminium. Seat and back upholstered in fabric, synthetic nubuck, synthetic leather or soft leather as per sample card.

Chaise tournante avec 4 rayons en aluminium gaufré graphite, blanc ou noir. Assise et dossier revêtus en tissu, synthetic nubuck, simili cuir ou cuir mince selon échantillons.

Silla giratoria con base con 4 radios en aluminio barnizado gofrado graphite, blanco o negro. Asiento y respaldo tapizados en tejido, synthetic nubuck, ecopiel o piel según muestrario.

Drehstuhl mit 4-Sterne-Basis aus Aluminium lackiert graphite, weiß oder schwarz gaufriert. Sitz und Rücken mit Stoff, synthetic nubuck, Kunstleder oder Softlederbezug, laut Musterkarte.

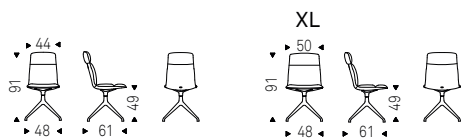

KELLY chair in soft leather 953 Ardesia and black frame









DIANA chairs in soft leather 951 Castoro and black frame

**DIANA****Design Archirivolto**

Sedia con struttura in frassino naturale, frassino tinto noce Canaletto, frassino tinto rovere bruciato, laccato poro aperto bianco o nero opaco. Seduta e schienale rivestiti in tessuto, synthetic nubuck, ecopelle o pelle come da campionario.

Chair with frame in natural ashwood, Canaletto walnut stained ashwood, burned oak stained ashwood, open pore matt white or black painted. Seat and back upholstered in fabric, synthetic nubuck, synthetic leather or soft leather as per sample card.

Chaise avec structure en frêne naturel, frêne teinté noyer Canaletto, frêne teinté rouvre brûlé ou laqué pore ouvert blanc ou noir opaque. Assise et dossier revêtus en tissu, synthetic nubuck, simili cuir ou cuir mince selon échantillons.

Silla con estructura en fresno natural, fresno barnizado nogal Canaletto, fresno barnizado roble ahumado, fresno barnizado a poro abierto blanco o negro mate. Asiento y respaldo tapizados en tejido, synthetic nubuck, ecopiel o piel según muestrario.

Stuhl mit Struktur in Esche gebeizt Esche Natur, Nussbaum Canaletto, "verbrannte Eiche", oder offenporig lackiert in den Farben weiß oder schwarz matt. Sitz und Rücken mit Stoff, synthetic nubuck, Kunstleder oder Softlederbezug, laut Musterkarte.

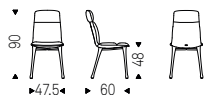







## MAGDA COUTURE

### Design Studio Kronos

Sedia con o senza braccioli con struttura in frassino naturale, frassino tinto noce Canaletto, frassino tinto rovere bruciato, frassino laccato poro aperto bianco o nero opaco. Seduta e schienale rivestiti in synthetic nubuck, ecopelle o pelle come da campionario. Retro schienale trapuntato. Non sfoderabile.

Chair with or without arms with frame in natural ashwood, Canaletto walnut stained ashwood, burned oak stained ashwood, open pore matt white or black painted ashwood. Seat and back upholstered in synthetic nubuck, synthetic leather or soft leather as per sample card. Quilted seatback cover. The cover is not removable.

Chaise avec ou sans accoudoirs, structure en frêne naturel, frêne teinté noyer Canaletto, frêne teinté rouvre brulé ou frêne laqué pore ouvert blanc ou noir opaque. Assise et dossier revêtus en synthetic nubuck, simili cuir ou cuir mince selon échantillons. Dos de siège matelassé. Le revêtement n'est pas déhoussable.

Silla con o sin brazos con estructura en fresno natural, fresno barnizado nogal Canaletto, fresno barnizado roble ahumado, fresno barnizado a poro abierto blanco o negro mate. Asiento y respaldo tapizados en synthetic nubuck, ecopiel o piel según muestrario. Respaldo exterior acolchado. El tapizado no es desenfundable.

Stuhl mit oder ohne Armlehnen, Gestell in Esche gebeizt Esche Natur, Nussbaum Canaletto, "verbrannte Eiche", oder Esche offenporig lackiert in den Farben weiß oder schwarz matt. Sitz und Rücken mit synthetic nubuck, Kunstleder oder Softlederbezug, laut Musterkarte. Rückseite gesteppt. Nicht abziehbar.

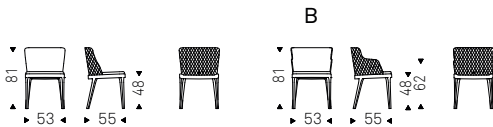

MAGDA B COUTURE armchairs in soft leather 956 Atlantico and burned oak frame





MAGDA COUTURE chairs in 948 Lino soft leather and burned oak frame



## WANDA

### Design Paolo Cattelan

Poltroncina imbottita con struttura in acciaio interamente rivestita in tessuto, ecopelle, synthetic nubuck o pelle come da campionario. Non sfoderabile.

Easy chair with steel frame and covered in fabric, synthetic leather, synthetic nubuck or soft leather as per sample card. The cover is not removable.

Petit fauteuil avec structure en acier, rembourré et complètement revêtu en tissu, simili cuir, synthetic nubuck ou cuir mince selon échantillons. Le revêtement n'est pas déhoussable.

Butaca con estructura en acero tapizada y completamente revestida en tejido, ecopiel, synthetic nubuck o piel según muestrario. El tapizado no es desenfundable.

Stuhl mit gepolstertem Stahlgestell mit Bezug aus Stoff, Kunstleder, synthetic Nubuck oder Softleder laut Musterkarte. Nicht abziehbar.

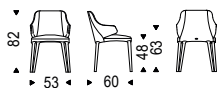

WANDA chair in 973 Nero soft leather











**INDY****Design Archirivolto**

Poltroncina in poliuretano morbido con varie basi. Base fissa o girevole in acciaio verniciato trasparente, gofrato titanio, graphite, bianco, nero o in legno faggio naturale, faggio tinto noce Canaletto o rovere bruciato o a 5 razze in alluminio lucido o alluminio verniciato nero opaco con ruote. Seduta in poliuretano monocoloro disponibile nei colori bianco, lino, fango, petrolio o antracite o bicolore retro petrolio e fronte fango. Per forniture superiori a 50 pz disponibili altri colori. Nuova base a 4 razze in nylon nei colori graphite, bianco o nero disponibile nella versione girevole e con ruote. Scocca ignifuga 1 IM - CRIB5.

Soft polyurethane armchair with different bases. Fix or swiveling base in transparent, titanium, graphite, white or black embossed lacquered steel or in natural beech, Canaletto walnut or burned oak stained beech, or with 5 spokes in polished aluminum, or with wheels in black painted aluminum. Seat and back in monochrome polyurethane available in white, lino, fango, petrolio or antracite colors, or two-tone polyurethane back petrolio and front fango. For supplies of more than 50 pieces are available other colors. New 4 spokes base in graphite, white or black nylon available in swiveling version and on wheels. Fireproof seat 1 IM - CRIB5.

Petit fauteuil en polyuréthane mou avec différentes bases. Base fixe ou pivotante en acier laqué transparent, gaufré titane, graphite, blanc ou noir ou en hêtre naturel, hêtre teinté noyer Canaletto ou rouvre brulé ou à 5 rayons en aluminium brillant ou aluminium laqué noir opaque avec roues. Assise et dossier en polyuréthane monochrome disponible dans les couleurs blanc, lin, boue, pétrole ou anthracite ou bicolore avec dos en pétrole et front en boue. Disponible en plusieurs couleurs pour ordres supérieurs à 50 pièces. Nouvelle base à 4 rayons en nylon dans les couleurs graphite, blanc ou noir. Disponible dans les versions pivotante ou avec roulettes. Cocque ignifuge 1IM-CRIB5.

Butaca en poliuretano blando con distintas bases. Base fija o giratoria en acero barnizado transparente, gofrado titanio, graphite, blanco, negro o en haya natural, haya pintada nogal Canaletto o roble ahumado o base con 5 radios con ruedas en aluminio brillo o aluminio barnizado negro mate. Asiento en poliuretano monocromo disponible en blanco, lino, fango, petróleo u antracita o bicolor petróleo por detrás y fango de frente. Para pedidos con más de 50 piezas disponibles otros colores. Nueva base con 4 radios en nylon en los colores graphite, blanco o negro disponible en la versión giratoria y con ruedas. Asiento ignífugo 1 IM - CRIB5.

Stuhl in Weich-Polyurethan mit verschiedenen Basis. Fest oder drehbarer mit Gestell in Edelstahl lackiert transparent, gaufriert Titan, graphit, weiß, schwarz oder in Buche natur, Buche gebeizt Nussbaum Canaletto oder verbrannte Eiche oder mit 5 Sterne-Sockel mit Rollen in Aluminium glänzend oder Aluminium schwarz lackiert. Sitz in Polyurethan unifarbig weiß, Lino, Fango, Petrolio oder Antracite oder zweifarbig: Petrolio und Fango. Für Bestellungen ab 50 Stücke sind auch andere Farben lieferbar. Neue 4-Sterne-Basis aus Nylon in den Farben graphite, weiss oder schwarz, verfügbar in den versionen drehbar und drehbar mit Rollen. Hülle feuerfest 1 IM - CRIB5.

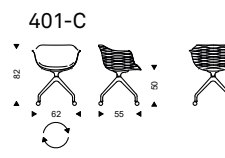
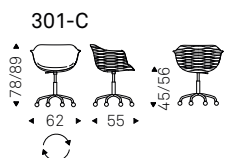
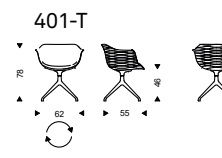
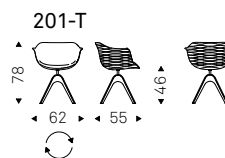
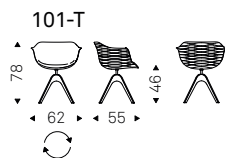
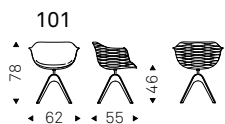





INDY 401-C chair in bicolor and black frame - INDY 401-T chair in P01 Bianco Lino and white chair INDY 401-T chairs in P02 Lino and black frame



BELINDA chairs in soft leather 973 Nero and burned oak frame

**BELINDA****Design Paolo Cattelan**

Sedia con struttura in frassino naturale, frassino tinto noce Canaletto, frassino tinto rovere bruciato, laccato poro aperto bianco o nero opaco. Seduta e schienale rivestiti in tessuto, synthetic nubuck, micro nubuck, ecopelle o pelle come da campionario.

Chair with frame in natural ashwood, Canaletto walnut stained ashwood, burned oak stained ashwood, open pore matt white or black painted. Seat and back upholstered in fabric, synthetic nubuck, micro nubuck, synthetic leather or soft leather as per sample card.

Chaise avec structure en frêne naturel, frêne teinté noyer Canaletto, frêne teinté rouvre brulé ou laqué pore ouvert blanc ou noir opaque. Assise et dossier revêtus en tissu, synthetic nubuck, micro nubuck, simili cuir ou cuir mince selon échantillons.

Silla con estructura en fresno natural, fresno barnizado nogal Canaletto, fresno barnizado roble ahumado, fresno barnizado a poro abierto blanco o negro mate. Asiento y respaldo tapizados en tejido, synthetic nubuck, micro nubuck, ecopiel o piel según muestrario.

Stuhl mit Struktur in Esche gebeizt Esche Natur, Nussbaum Canaletto, "verbrannte Eiche", oder offenporig lackiert in den Farben weiß oder schwarz matt. Sitz und Rücken mit Stoff, synthetic nubuck, micro nubuck, Kunstleder oder Softlederbezug, laut Musterkarte.

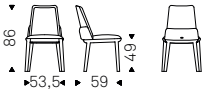

BELINDA chair in soft leather 951 Castoro and black frame



BELINDA chair in soft leather 951 Castoro and black frame





BELINDA chair in soft leather 951 Castoro and walnut Canaletto frame

## KAY COUTURE

### Design Paolo Cattelan

Sedia imbottita con struttura in acciaio interamente rivestita in ecopelle, synthetic nubuck o pelle come da campionario. Retro schienale trapuntato. Non sfoderabile.

Upholstered chair with steel frame and covered in synthetic leather, synthetic nubuck or soft leather as per sample card. Quilted seatback cover. The cover is not removable.

Chaise avec structure en acier, rembourrée et complètement revêtue en simili cuir, synthetic nubuck ou cuir mince selon échantillons. Dos de siège matelassé. Le revêtement n'est pas déhoussable.

Silla con estructura en acero tapizada y completamente revestida en ecopiel, synthetic nubuck o piel según muestrario. Respaldo acolchado. El tapizado no es desenfundable.

Stuhl mit gepolstertem Stahlgestell mit Bezug aus Kunstleder, synthetic Nubuck oder Softleder laut Musterkarte. Rückseite gesteppt. Nicht abziehbar.

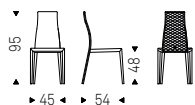

KAY COUTURE chairs in soft leather 956 Atlantico



## KAY

### Design Paolo Cattelan

Sedia imbottita con struttura in acciaio interamente rivestita in tessuto, ecopelle, synthetic nubuck, micro nubuck o pelle come da campionario. Non sfoderabile.

Upholstered chair with steel frame and covered in fabric, synthetic leather, synthetic nubuck, micro nubuck or soft leather as per sample card. The cover is not removable.

Chaise avec structure en acier, rembourrée et complètement revêtue en tissu, simili cuir, synthetic nubuck, micro nubuck ou cuir mince selon échantillons. Le revêtement n'est pas déhoussable.

Silla con estructura en acero tapizada y completamente revestida en tejido, ecopiel, synthetic nubuck, micro nubuck o piel según muestrario. El tapizado no es desenfundable.

Stuhl mit gepolstertem Stahlgestell mit Bezug aus Stoff, Kunstleder, synthetic Nubuck, micro Nubuck oder Softleder laut Musterkarte. Nicht abziehbar.

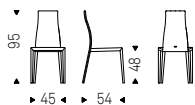

KAY chairs in soft leather 950 tortora



## DUMBO LOUNGE

### Design Archirivolto

Poltroncina con struttura in frassino tinto noce Canaletto, frassino tinto rovere bruciato, frassino laccato poro aperto bianco o nero opaco. Seduta e schienale rivestiti in tessuto, ecopelle, synthetic nubuck o pelle come da campionario.

Armchair with frame in Canaletto walnut stained ashwood, burned oak stained ashwood or open pore matt white or black ashwood. Seat and back upholstered in fabric, synthetic nubuck or soft leather as per sample card.

Petit fauteuil avec structure frêne teinté noyer Canaletto, rouvre brûlé ou laqué blanc ou noir opaque pore ouvert. Assise et dossier revêtus en tissu, simili cuir, synthetic nubuck ou cuir mince selon échantillons.

Butaca con estructura en fresno barnizado nogal Canaletto, roble ahumado, fresno barnizado blanco o negro mate a poro abierto. Asiento y respaldo tapizados en tejido, ecopiel, synthetic nubuck o piel según muestrario.

Sessel mit Gestell aus Esche gebeizt Nussbaum Canaletto, "verbrannte Eiche", oder offenporig lackiert in den Farben weiß oder schwarz matt. Sitz und Rücken mit Stoff, Kunstleder, synthetic Nubuck oder Softlederbezug, laut Musterkarte.

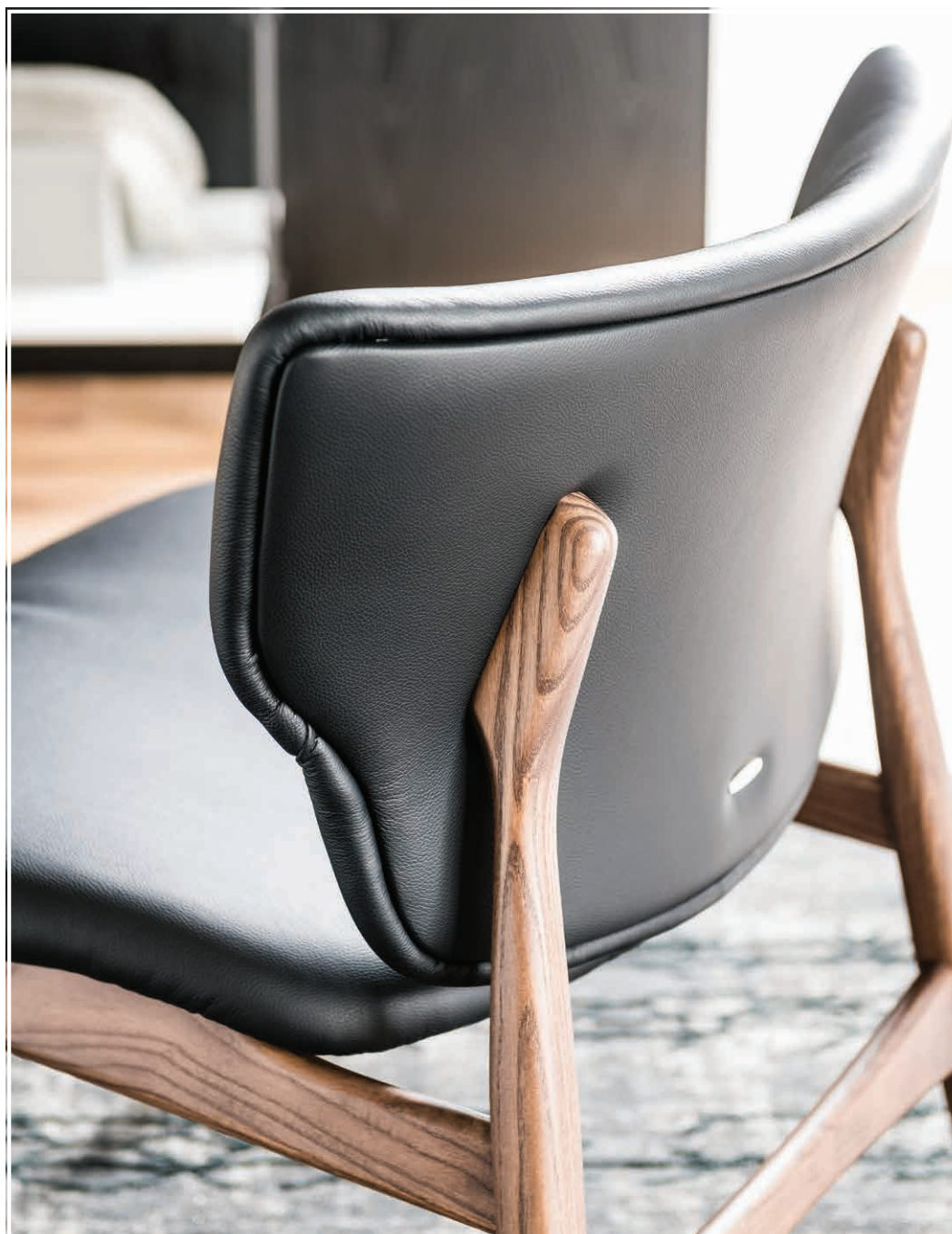



DUMBO LOUNGE chair in soft leather 973 Nero and walnut Canaletto frame

## DUMBO SGABELLO

### Design Archirivolto

Sgabello con struttura in frassino tinto noce Canaletto, frassino tinto rovere bruciato, frassino laccato poro aperto bianco o nero opaco. Seduta e schienale rivestiti in tessuto, synthetic nubuck, ecopelle o pelle come da campionario.

Stool with frame in Canaletto walnut stained ashwood, burned oak stained ashwood or open pore matt white or black painted ashwood. Seat and back upholstered in fabric, synthetic nubuck, synthetic leather or soft leather as per sample card.

Tabouret avec structure en frêne teinté noyer Canaletto, frêne teinté rouvre brulé ou frêne laqué pore ouvert blanc ou noir opaque. Assise et dossier revêtus en tissu, synthetic nubuck, simili cuir ou cuir mince selon échantillons.

Taburete con estructura en fresno barnizado nogal Canaletto, fresno barnizado roble ahumado, fresno barnizado a poro abierto blanco o negro mate. Asiento y respaldo tapizados en tejido, synthetic nubuck, ecopiel o piel según muestrario.

Barhocker mit Struktur in Esche gebeizt Nussbaum Canaletto, "verbrannte Eiche", oder Esche offenporig lackiert in den Farben weiß oder schwarz matt. Sitz und Rücken mit Stoff, synthetic nubuck, Kunstleder oder Softlederbezug, laut Musterkarte.

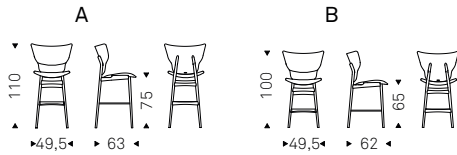

DUMBO SGABELLO stool in soft leather 948 Lino and burned oak frame - DUMBO SGABELLO stool in soft leather 973 Nero and walnut Canaletto frame





DUMBO SGABELLO stools in soft leather 948 Lino and burned oak frame - TRESOR shelf with black frame and bronze mirror - FISHERMAN lamps in titanium finish

## AXEL-X

### Design Archirivolto

Sgabello ultraleggero regolabile in altezza e girevole con base a 4 razze in alluminio lucido, colonna, poggiatesta e pistone a gas in acciaio cromato o base, colonna, poggiatesta verniciati gofrato nero o titanio e pistone a gas in acciaio cromato. Scocca rivestita in tessuto, synthetic nubuck, ecopelle o pelle come da campionario.

Swiveling ultralight stool, adjustable in height with 4 spokes base in polished aluminium and column, footrest and gas piston in chromed steel or with base plate, column, and footrest in black or titanium embossed lacquered steel and gas piston in chromed steel. Frame covered in fabric, synthetic nubuck, synthetic leather or soft leather as per sample card.

Tabouret ultraléger réglable en hauteur et pivotant. Base avec 4 rayons en aluminium poli, colonne, repose-pieds et piston en acier chromé ou base, colonne et repose-pieds gaufrés noir ou titane et piston en acier chromé. Assise en tissu, synthetic nubuck, simili cuir ou cuir mince selon échantillons.

Taburete ultraligero regulable en altura y giratorio con base con 4 radios en aluminio brillo, columna, reposapiés y pistón de gas en acero cromado o base, columna, reposapiés barnizados gofrado negro o titanio y pistón de gas en acero cromado. Respaldo tapizado en tejido, synthetic nubuck, ecopiel o piel según muestrario.

Superleicht Höhenverstellbarer und drehbarer Barhocker mit 4-Sterne-Basis aus poliertem Aluminium, Säule, Fußraste und Gas Druckfeder aus verchromtem Stahl, oder Basis, Säule, Fußraste in Stahl lackiert schwarz oder Titan gaufriert und Gas Druckfeder aus verchromten Stahl. Sitzbezug in Stoff, synthetic nubuck, Kunstleder oder Softleder laut Musterkarte.

## AXEL-X



## AXEL



AXEL-X SGABELLO stools in soft leather 948 Lino and black frame







**MAGDA COUTURE  
SGABELLO**

**Design Studio Kronos**

Sgabello con o senza braccioli con struttura in frassino naturale, frassino tinto noce Canaletto, frassino tinto rovere bruciato, frassino laccato poro aperto bianco o nero opaco. Seduta e schienale rivestiti in synthetic nubuck, ecopelle o pelle come da campionario. Retro schienale trapuntato. Non sfoderabile.

Stool with or without arms with frame in natural ashwood, Canaletto walnut stained ashwood, burned oak stained ashwood, open pore matt white or black painted ashwood. Seat and back upholstered in synthetic nubuck, synthetic leather or soft leather as per sample card. Quilted seatback cover. The cover is not removable.

Tabouret avec ou sans accoudoirs, structure en frêne naturel, frêne teinté noyer Canaletto, frêne teinté rouvre brulé ou frêne laqué pore ouvert blanc ou noir opaque. Assise et dossier revêtus en synthetic nubuck, simili cuir ou cuir mince selon échantillons. Dos de siège matelassé. Le revêtement n'est pas déhoussable.

Taburete con o sin brazos con estructura en fresno natural, fresno barnizado nogal Canaletto, fresno barnizado roble ahumado, fresno barnizado a poro abierto blanco o negro mate. Asiento y respaldo tapizados en synthetic nubuck, ecopiel o piel según muestrario. Respaldo exterior acolchado. El tapizado no es desenfundable.

Barhocker mit oder ohne Armlehnen, Gestell in Esche gebeizt Esche Natur, Nussbaum Canaletto, "verbrannte Eiche", oder Esche offenporig lackiert in den Farben weiß oder schwarz matt. Sitz und Rücken mit synthetic nubuck, Kunstleder oder Softlederbezug, laut Musterkarte. Rückseite gesteppt. Nicht abziehbar.

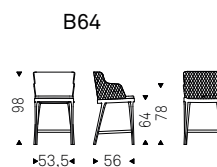
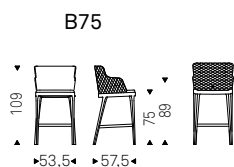
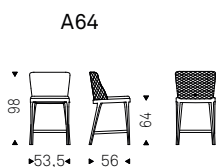
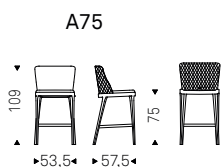

MAGDA COUTURE SGABELLO A64 stools in soft leather 947 oyster and walnut canaletto



MAGDA COUTURE SGABELLO B75 stools in soft leather 956 Atlantico and burned oak frame

## ARIZONA

### Design Alessio Bassan

Madia a quattro ante in Brushed Bronze. Top in cristallo extrachiaro verniciato graphite. Piedi in acciaio verniciato gofrato nero. Ripiani interni in legno color graphite.

Sideboard with 4 doors in Brushed Bronze. Top in extra clear graphite painted glass. Black embossed lacquered steel feet. Internal shelves in graphite painted wood.

Bahut à quatre portes en Brushed Bronze. Plateau en verre extra-clair laqué graphite opaque. Pieds en acier gaufré noir. Étagères internes en bois peint en graphite.

Aparador con 4 puertas en Brushed Bronze. Sobre en cristal extraclaro barnizado graphite. Patas en acero barnizado gofrado negro. Estantes interiores en madera barnizada graphite.

Anrichte 4-trg, Türenfronten in Brushed Bronze. Platte aus Glas extra hell graphite lackiert. Füße aus Stahl lackiert schwarz gaufriert. Innenböden in graphit lackiertem Holz.

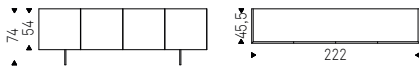





ARIZONA sideboard - BELINDA chairs in soft leather D73 Nero and burned oak - RADJA rug





ARIZONA sideboard - TRESOR shelves with black frame and bronze mirror

## ASTON

### Design STC studio

Madia contenitore in legno goffrato titanio o nero e base in acciaio goffrato nero. Anta sinistra rivestita in pelle trapuntata nei colori come da campionario con profili in alluminio verniciato titanio goffrato. Vano centrale con specchio. Anta destra in noce Canaletto o rovere bruciato con particolari in cromo nero. Ripiani interni in cristallo fumè.

Sideboard in lacquered titanium or black embossed wood. Black embossed steel base. Left door covered and quilted in soft leather as per sample card with embossed titanium aluminum profiles. Central section with mirror. Right door in Canaletto walnut or burned oak with black chrome details. Internal fumé glass shelves.

Bahut en bois gaufré titane ou noir et base en acier gaufré noir. Porte à gauche revêtue en cuir mince matelassé selon échantillons profilé en aluminium gaufré titane. Partie centrale avec miroir. Porte à droite en noyer Canaletto ou rouvre brûlé avec particuliers en chrome noir. Étagères en verre fumé.

Aparador en maderagofrado titanio o negro con patas en acero gofrado negro. Puerta izquierda revestida y acolchada en piel según muestrario y perfil en aluminio gofrado titanio. Parte central con espejo. Puerta derecha en nogal Canaletto o roble ahumado y detalles en cromo negro. Estantes interiores en cristal fumé.

Anrichte in Holz Titan oder schwarz gaufriert mit Basis aus Stahl schwarz gaufriert. Linke Tür bezogen mit Softleder gesteppt laut Musterkarte und Aluminium Rahmen in Titan gaufriert. Mittlere Raum mit Spiegel. Rechte Tür in Nussbaum Canaletto oder "verbrannte Eiche" mit Einsätze in schwarz Chrome. Innenböden aus fumé Glas.

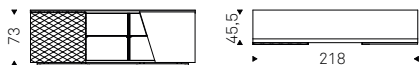



ASTON sideboard with doors in soft leather 948 Lino and burned oak, with black structure – WISH mirrors

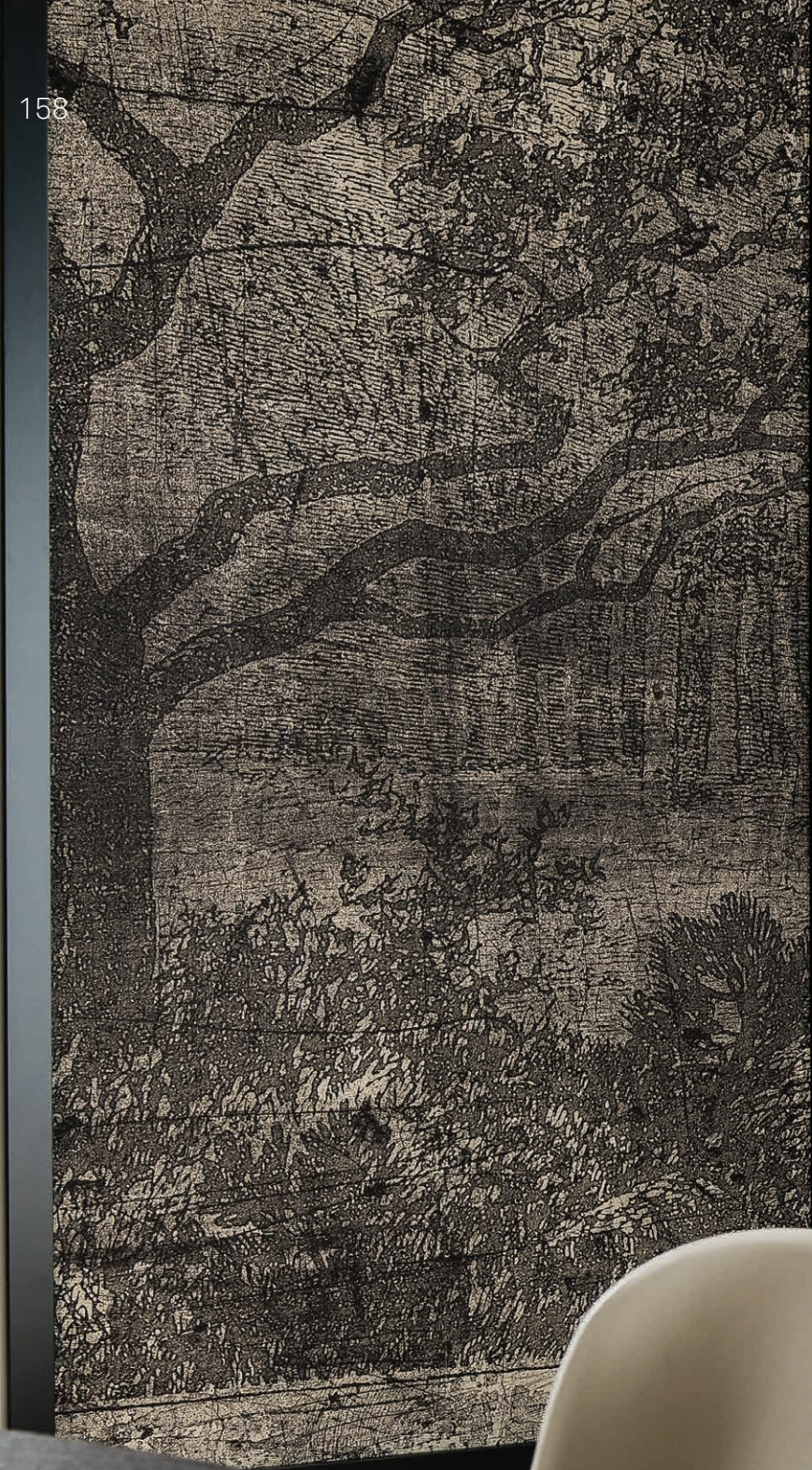



ASTON sideboard with doors in soft leather 948 Lino and burned oak, with black structure – WISH mirrors with brushed bronze frame – MANHATTAN floor lamp in black



PADDOCK sideboard in black and burned oak - TUCSON floor lamp in black - MUMBAI rugs



**PADDOCK****Design Alessio Bassan**

Madia in legno gofrato graphite o bianco e ante in noce Canaletto o gofrato nero con ante e ripiano inferiore in rovere bruciato.

Sideboard in lacquered graphite or white embossed wood with doors in Canaletto walnut or lacquered black embossed wood with doors and lower shelf in burned oak.

Bahut en bois gaufré graphite ou blanc avec portes en bois noyer Canaletto, ou gaufré noir avec portes et étagère inférieure en rouvre brûlé.

Aparador en madera gofrada graphite o blanco y puertas en nogal Canaletto o gofrado negro con puertas y estante inferior en roble ahumado.

Anrichte in Holz graphite oder weiss gaufriert und Türen in Nussbaum Canaletto, oder schwarz gaufriert mit Türen und untere Platte in "verbrannte Eiche".

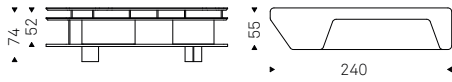







PADDOCK tv stand in black and burned oak - TUCSON floor lamp in black

**PADDOCK TV****Design Alessio Bassan**

Porta TV in legno gofrato graphite o bianco e cassetto in noce Canaletto o gofrato nero con cassetto e ripiano inferiore in rovere bruciato.

TV stand in lacquered graphite or white embossed wood with drawer in Canaletto walnut or lacquered black embossed wood with drawer and lower shelf in burned oak.

Meuble porte-TV en bois gaufré graphite ou blanc avec tiroir en bois noyer Canaletto, ou gaufré noir avec tiroir et étagère inférieure en rouvre brulé.

Mueble para TV en madera gofrado graphite o blanco y cajón en nogal Canaletto o gofrado negro con cajón y estante inferior en roble ahumado.

TV-Schrank in Holz graphite oder weiss gaufriert mit Schublade in Nussbaum Canaletto, oder schwarz gaufriert mit Schublade und untere Platte in "verbrannte Eiche".

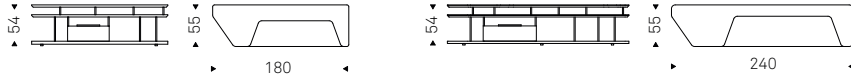

PADDOCK tv stand in white and Canaletto walnut





PADDOCK tv stand in black and burned oak - TUCSON floor lamp in black

## EUROPA KERAMIK

### Design

#### A. Lucatello & P. Cattelan

Madia con ante scorrevoli complanari e inserto nel top in ceramica Marmi nei colori Calacatta, Alabastro, Ardesia, Golden Calacatta opaco, Golden Calacatta lucido, Portoro opaco, Portoro lucido o ceramica Zinc nel colore Brown. Struttura verniciata graphite opaco. Ripiani interni in cristallo trasparente.

Sideboard with sliding doors and insert into the top in ceramic Marmi Calacatta, Alabastro, Ardesia, matt Golden Calacatta, glossy Golden Calacatta, matt Portoro, glossy Portoro or ceramic Zinc Brown. Matt graphite painted frame. Internal shelves in clear glass.

Bahut avec portes coulissantes et insert du plateau en céramique dans les couleurs Marmi Calacatta, Alabastro, Ardesia, Golden Calacatta opaque, Golden Calacatta brillant, Portoro opaque, Portoro brillant ou Zinc Brown. Structure laquéé graphite opaque. Étagères intérieures en verre clair.

Aparador con puertas correderas y sobre con detalle en cerámica Marmi en los colores Calacatta, Alabastro, Ardesia, Golden Calacatta mate, Golden Calacatta brillo, Portoro mate, Portoro brillo o cerámica Zinc Brown. Estructura barnizada graphite mate. Estantes interiores en cristal transparente.

Sideboard mit komplanaren Schwebetüre, Keramik Marmi Einsetze im Top, in den Farben Calacatta, Alabastro, Ardesia, matt Golden Calacatta, glänzend Golden Calacatta, matt Portoro, glänzend Portoro oder Keramik Zinc Brown. Korpus lackiert graphit matt. Innenböden in Klarglas.

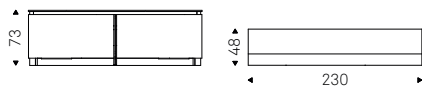





EUROPA KERAMIK sideboard in Glossy Portoro ceramic and graphite frame – TRESOR shelf with bronzed mirror and black structure – MUMBAI rug





EUROPA KERAMIK sideboard in Glossy Portoro ceramic and graphite frame - TRESOR shelf with bronzed mirror and black structure

## AIRPORT

### Design Giorgio Cattelan

Libreria componibile con fissaggio a muro o a soffitto. Montanti e staffe in acciaio verniciato gofrato titanio, bianco, nero o graphite. Ripiani e contenitori in legno verniciato gofrato bianco, graphite, in noce Canaletto, rovere bruciato o Brushed Bronze.

Modular wall- or ceiling-hanging bookcase. Brackets and pillars in titanium, white, black or graphite embossed lacquered steel. Shelves and containers in Canaletto walnut, burned oak, embossed white or graphite painted wood or Brushed Bronze.

Bibliothèque à éléments avec fixation au mur ou au plafond. Montants et supports en acier gaufré titane, blanc, noir ou graphite. Étagères et conteneurs en bois gaufré blanc, graphite, en noyer Canaletto, rouvre brulé ou Brushed Bronze.

Estantería componible con montaje en pared o techo. Montantes y soportes en acero barnizado gofrado titanio, blanco, negro o graphite. Estantes y contenedores en madera barnizada gofrado blanco, graphite, nogal Canaletto, roble ahumado o Brushed Bronze.

Anbau Regal mit Wand- oder Deckebefestigung. Gestell und Bügel in Stahl lackiert titan, weiß, schwarz oder graphite gaufriert. Böden und Container in Holz lackiert weiß gaufriert oder graphite, Nussbaum Canaletto oder "verbrannte Eiche" oder Brushed Bronze.

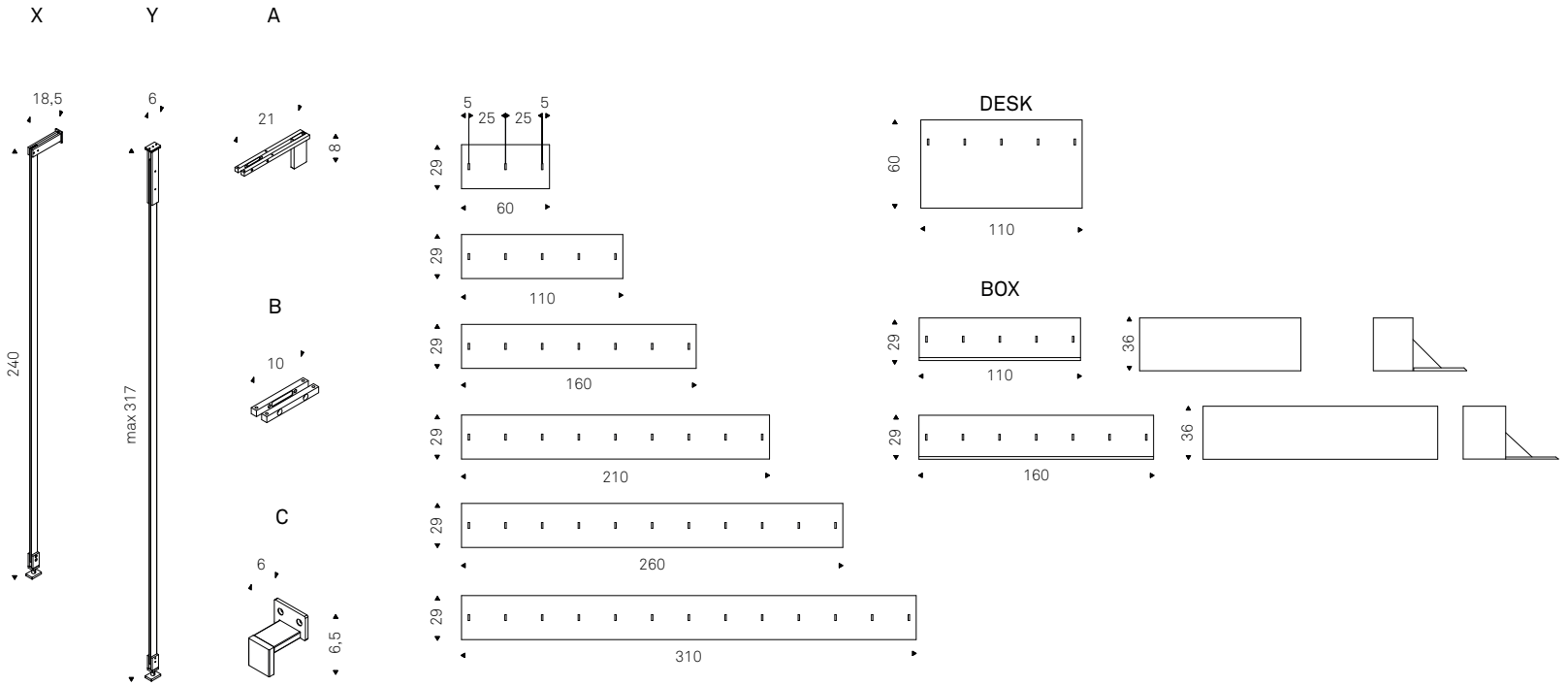





AIRPORT bookcase with Brushed Bronze shelves and black frame - SOHO ROUND KER-WOOD table with black base and top in Alabastro ceramic and walnut Canaletto  
POSEIDON 24 lamp in black finish - ARIZONA sideboard - PINKO pouf in soft leather 951 Castoro

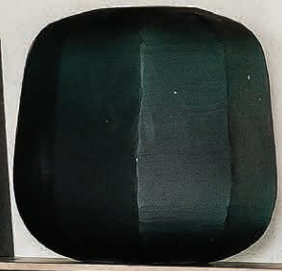

## WALLY

### Design Philip Jackson

Libreria componibile in MDF laccato bronzo, bianco, nero, graphite, oyster o ottanio goffrato fine.

Modular bookcase in bronze, white, black, graphite, oyster or ottanio lacquered embossed MDF.

Bibliothèque modulable en MDF gaufré bronze, blanc, noir, graphite, oyster ou ottanio.

Estantería modular en MDF gofrado, lacado en bronce, blanco, negro, graphite, oyster u octano.

Anbaubücherregal aus Bronze, weiß, schwarz, graphite, oyster oder ottanio gaufriertem MDF.

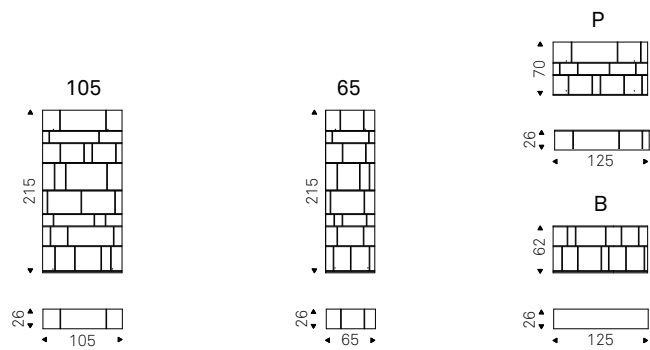







WALLY bookcases in bronze - WALL STREET desk in black with matt Golden Calacatta ceramic top



## FIFTY

### Design Luigi Trenti

Libreria componibile a muro in legno gofrato bronzo, bianco o graphite. Fornita di attacchi per aggancio sopra/sotto.

Modular wall bookcase in bronze, white or graphite lacquered embossed wood. Supplied with joints for upside/down hooking.

Bibliothèque murale à éléments en bois gaufré bronze, blanc ou graphite. Fournie avec fixation haut/bas.

Estantería modular a pared en madera lacada bronce, blanco o graphite gofrado fino. Furnido con enganche para montaje invertido.

Wandanbauregal, Holz Bronze, weiß oder graphite lackiert gaufriert. Mit Verbindungsstücke für umgekehrte Montage.

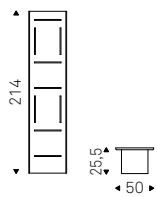



FIFTY bookcases in bronze – KAY COUTURE chair in soft leather 956 Atlantico – SUNSET abat-jour with brass structure and fumé glass



HARLEM bookcase in white - RADJA rug



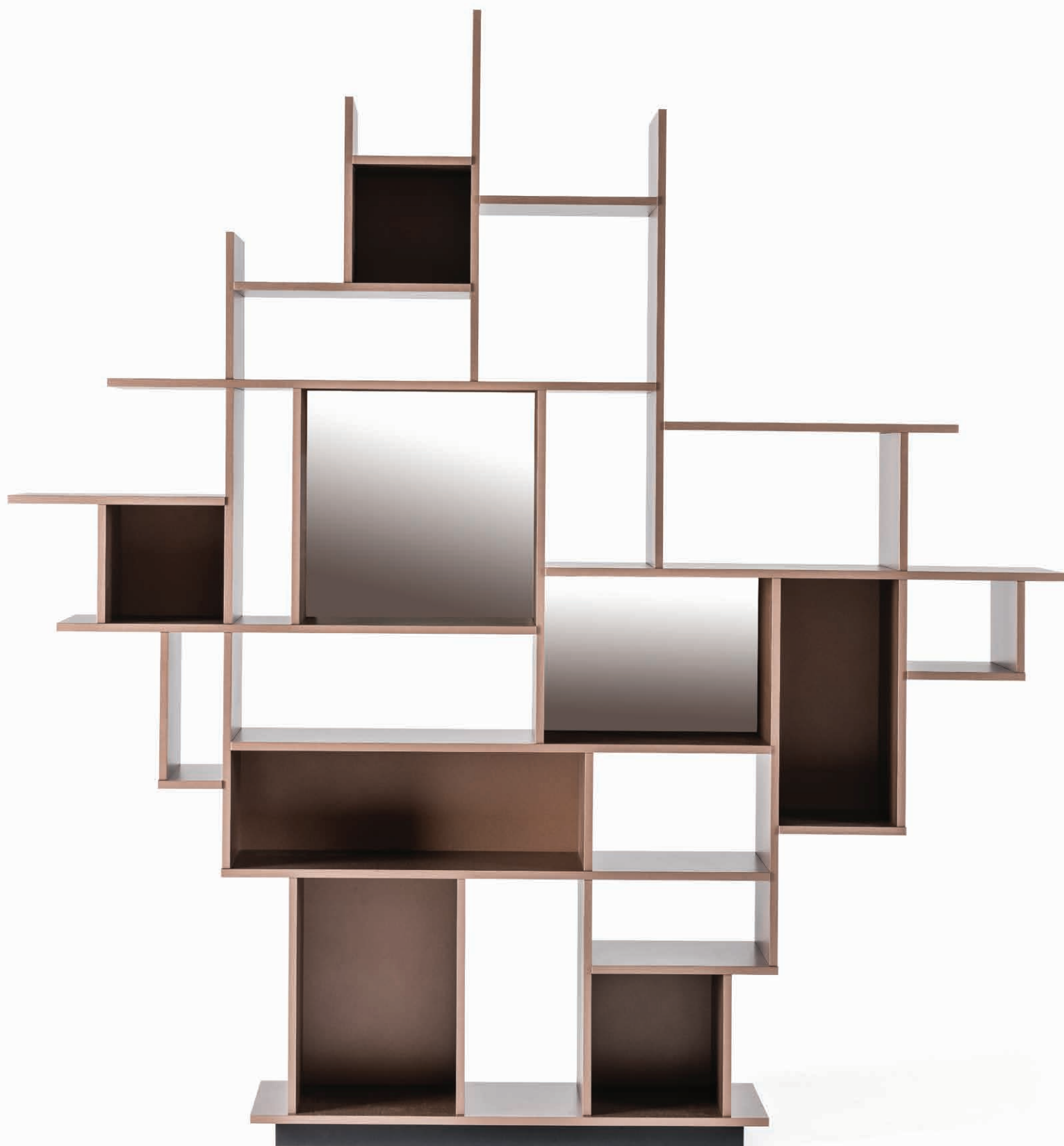





HARLEM bookcase in bronze – BILLY KERAMIK coffee tables with brushed bronze base and Glossy Portoro ceramic - BILLY coffee table with brushed bronze base and bronze top

## TRESOR

Design

**P. Cattelan & C. Rocchetti**

Mensola in acciaio verniciato gofrato titanio o nero e cristallo specchiato fumé o specchiato bronzo.

Shelf in titanium or black embossed lacquered steel and fumé or bronze mirrored glass.

Tablette en acier gaufré titane ou noir et verre miroité fumé ou miroité bronze.

Estante de pared en acero barnizado gofrado titanio o negro y cristal reflejado fumé o reflejado bronzo.

Wandregal aus Stahl lackiert Titan oder schwarz gaufriert und Glas verspiegelt fumé oder Bronze.

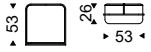







## WISH

### Design Paolo Cattelan

Specchio da parete in  
cristallo specchiato.  
Cornice in acciaio verniciato  
trasparente, gofrato  
graphite o nero, o Brushed  
Bronze.

Wall mirror in mirrored  
glass. Frame in transparent  
varnished steel, graphite or  
black embossed lacquered  
steel, or Brushed Bronze  
lacquered steel.

Miroir mural avec cadre  
en acier laqué transparent,  
gaufré graphite ou noir, ou  
laqué Brushed Bronze.

Espejo de pared en cristal  
reflejado. Marco en acero  
barnizado transparente,  
gofrado graphite o negro, o  
Brushed Bronze.

Wandspiegel in Glas  
verspiegelt. Rahmen in  
Metall lackiert transparent,  
graphite oder schwarz  
gaufriert oder lackiert  
Brushed Bronze.

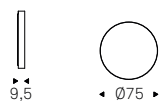







**EMERALD****Design Paolo Cattelan**

Specchio da parete o da terra tutto in cristallo specchiato o specchiato fumé.

Wall or floor mirror with the whole frame in mirrored glass or fumé glass.

Miroir de mur ou de sol tout en verre miroité ou miroité fumé.

Espejo de pared o suelo todo en cristal reflejado o reflejado fumé.

Wandspiegel oder Bodenspiegel ganz aus Glas verspiegelt oder verspiegelt fumé.

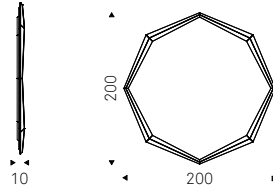
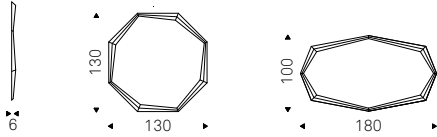
**EMERALD MAGNUM**

## BILLY

### Design Studio Kronos

Tavolino con base in acciaio cromato o verniciato goffrato nero. Piano in cristallo colorato (rosso, nero, marrone, grey, graphite) o specchiato. Base in Brushed Bronze e piano in cristallo specchiato bronzo.

Coffee table with base in chromed steel or embossed black lacquered steel. Coloured (red, black, brown, grey, graphite) or mirrored glass top. Brushed Bronze steel base and mirrored bronze glass top.

Table basse avec base en acier chromé ou gaufré noir. Plateau en verre coloré (rouge, noir, marron, grey, graphite) ou miroité. Base en acier Brushed Bronze et Plateau en verre miroité bronze.

Mesita con base en acero cromado o barnizado gofrado negro. Sobre en cristal colorado (rojo, negro, marrón, grey, graphite) o reflejado. Base en acero Brushed Bronze y sobre en cristal reflejado bronzo.

Couchtisch mit Basis aus verchromtem Stahl oder lackiert schwarz gaufriert. Platte aus farbigem Glas (rot, schwarz, braun, grey, graphite) oder verspiegeltem Glas. Basis aus Brushed Bronze und Platte aus Glas verspiegelt Bronze.

## BILLY KERAMIK

### Design Studio Kronos

Tavolino con base in acciaio cromato, verniciato goffrato nero o Brushed Bronze. Piano in ceramica Marmi nei colori Calacatta, Alabastro, Ardesia, Portoro opaco o Portoro lucido.

Coffee table with base in chromed steel, embossed black lacquered steel or Brushed Bronze. Marmi Calacatta, Alabastro, Ardesia, matt Portoro or glossy Portoro ceramic top.

Table basse avec base en acier chromé, gaufré noir ou Brushed Bronze. Plateau en céramique Marmi dans les couleurs Calacatta, Alabastro, Ardesia, Portoro opaque ou Portoro brillant.

Mesita con base en acero cromado, barnizado gofrado negro o Brushed Bronze. Sobre en cerámica Marmi colores Calacatta, Alabastro, Ardesia, Portoro mate o Portoro brillo.

Couchtisch mit Basis aus verchromtem Stahl, lackiert schwarz gaufriert oder Brushed Bronze. Platte in Keramik Marmi in den Farben Calacatta, Alabastro, Ardesia, matt Portoro oder glänzend Portoro.

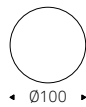
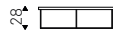
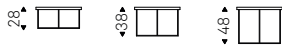



BILLY KERAMIK coffee tables with brushed bronze base and Glossy Portoro ceramic - BILLY coffee table with brushed bronze base and bronze top  
HARLEM bookcase in bronze - RADJA rug





BILLY KERAMIK coffee tables with brushed bronze base and Glossy Portoro ceramic ~ BILLY coffee table with brushed bronze base and bronze top  
~ HARLEM bookcase in bronze ~ RADJA rug



**CARRÈ****Design Giorgio Cattelan**

Tavolino in cristallo  
trasparente curvato. Optional  
vassoio inox.

Coffee table in curved clear  
glass. Optional stainless  
steel tray.

Table basse en verre courbé  
clair. Plateau inox optionnel.

Mesita en cristal  
transparente curvado.  
Bandeja opcional en acero  
inox.

Couchtisch aus gebogenem  
Klarglas. Optional Edelstahl-  
Tablett.

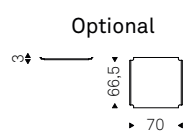
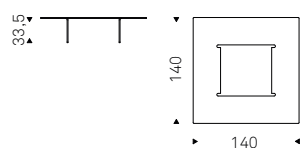









**SKYLINE TAVOLINO**

**Design Brogliato & Traverso**

Tavolino con base in acciaio verniciato gofrato titanio, graphite o nero. Piano in cristallo trasparente.

Coffee table with titanium, graphite or black embossed lacquered steel base. Top in clear glass.

Table basse avec base en acier gaufré titane, graphite ou noir. Plateau en verre clair.

Mesita con base en acero barnizado gofrado titanio, graphite o negro. Sobre en cristal transparente.

Couhtisch mit Basis in Edelstahl lackiert titan, graphite oder schwarz gaufriert. Platte in Klarglas.

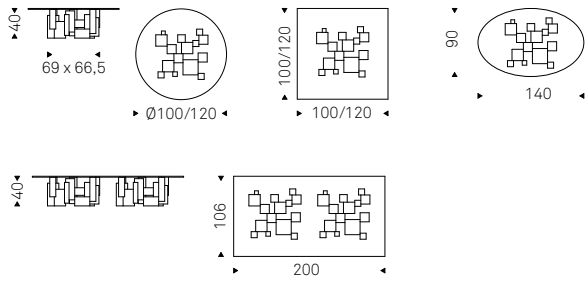



SKYLINE coffee table with titanium base and clear glass top - RADJA rugs





**OSLO****Design Paolo Cattelan**Tavolino in acciaio cromo  
nero.Coffee table in black  
chrome steel.Table basse en acier  
chromé noir.Mesita en acero cromo  
negro.Couchtisch aus  
Stahl  
schwarz verchromt.





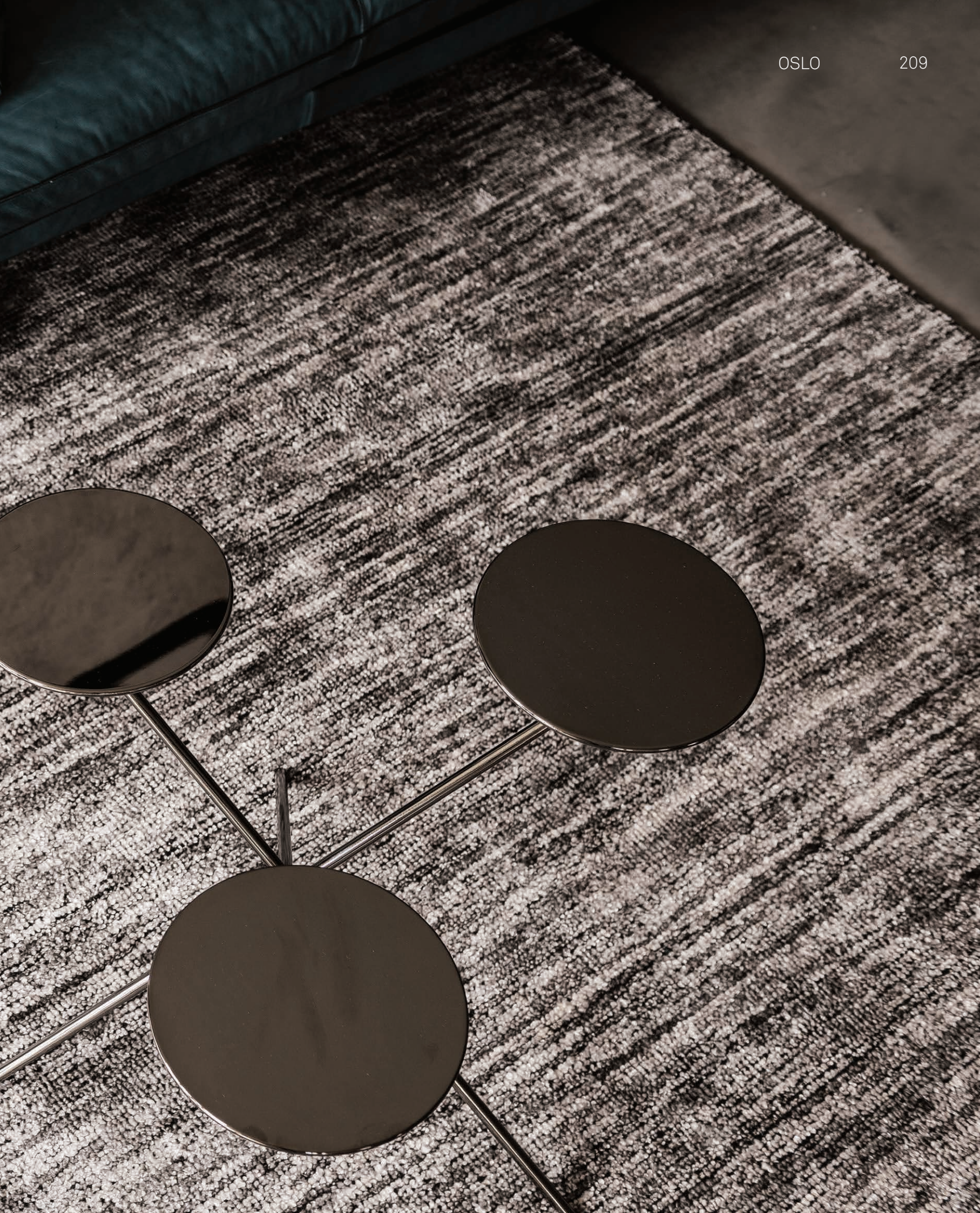

**MIDA**

**Design Brogliato & Traverso**

Tavolino in legno verniciato nero opaco e Brushed Bronze.

Coffee table in matt black lacquered wood and Brushed Bronze.

Table basse en bois laqué noir opaque et Brushed Bronze.

Mesita en madera lacada negro mate y Brushed Bronze.

Couchtisch aus Holz schwarz lackiert matt und Brushed Bronze.

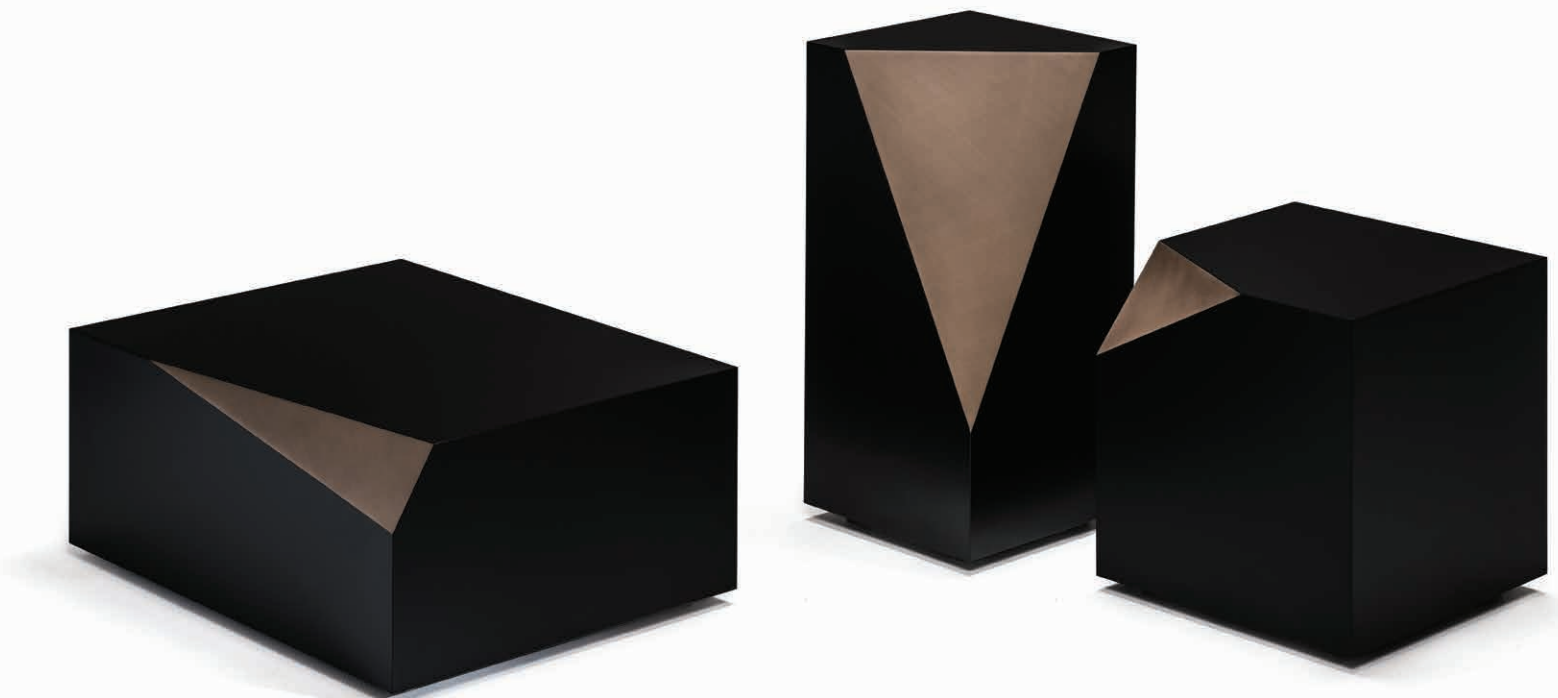
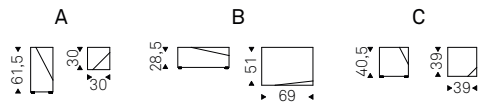



## CLOUDINE

### Design Oriano Favaretto

Lampada a soffitto con paralume in cristallo Iride o fumé. Attacco a soffitto in acciaio Nichel satinato. 1: attacco singolo. 2/6: attacco rotondo da 2 a 6 paralumi. 7/12: attacco rotondo da 7 a 12 paralumi. Lampadina inclusa.

Ceiling lamp with lampshade in Iride glass or fumé glass. Ceiling plate in satin Nickel steel. 1: single plate. 2/6: round ceiling plate for 2/6 lampshades. 7/12: round ceiling plate for 7/12 lampshades. Bulb included.

Lampadaire avec diffuseur en verre Iride ou fumé et plafond en Nickel satiné. 1: culot single. 2/6: culot rond de 2/6 abat-jours. 7/12: culot ronde de 7/12 abat-jours. Ampoule comprise.

Lámpara de techo con pantalla en cristal Iride o fumé. Soporte de techo en acero Níquel satinado. 1: soporte único. 2/6: soporte redondo para 2/6 pantallas. 7/12: soporte redondo para 7/12 pantallas. Bombilla incluida.

Hängelampe mit Lampenschirm in Kristall Iride oder fumé. Deckenbefestigung in Nickel satiniert. 1: Einzelne Anschluss. 2/6: Runde Anschluss für 2/6 Lampenschirme. 7/12: Runde Anschluss für 7/12 Lampenschirme. Leuchtmittel enthalten.

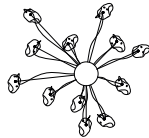
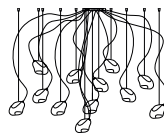
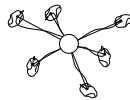
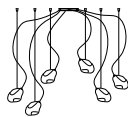
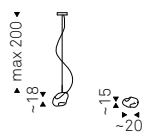

### Lamp

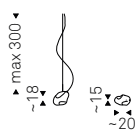

### Socket 2/6



### Socket 7/12









МОНЕИ АНО БУТЕД  
Нестори Билешић  
КЕМИЕЛН ОДЗЕЛВАЕ  
Gipsius V BO  
V  
abonovani amA • mililici

GIRLS ATOP  
SAVAGE MESSIAH  
FER PARGALY



## PHOENIX

### Design STC Studio

Lampada a soffitto con struttura in acciaio Nichel satinato ed elementi in vetro lavorati a mano. Illuminazione a led.

Ceiling lamp with satin Nickel steel frame and handmade glass elements. Led lights.

Lampadaire avec structure en acier Nickel satiné et éléments en verre. Forgés à la main. Éclairage à led.

Lámpara de techo con estructura en acero Níquel satinado y elementos en vidrio hechos a mano. Iluminación led.

Hängelampe mit Stahlgestell in Nickel satiniert und Glaselementen handgearbeitet. LED Beleuchtung.

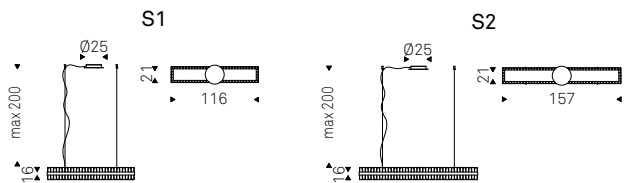







**LANCELOT****Design Oriano Favaretto**

Lampada a soffitto con struttura in acciaio verniciato bronzo e inserti ottone. Elementi a forma di candela in vetro pulegoso di Murano lavorato a mano. Illuminazione a led sotto e sopra. Ogni elemento in vetro è unico e diverso nella forma e nella misura.

Ceiling lamp in bronze embossed lacquered steel and brass inserts. Candle shape elements in handmade pulegoso Murano glass. Downward and upward led lighting. Every glass element is unique and different in size and shape.

Lampadaire avec structure en acier lacqué bronze et détails en laiton. Elements à bougie forgés à la main en verre pulegoso de Murano. Éclairage à led supérieur et inférieur. Chaque élément est unique et différent en forme et dimension.

Lámpara de techo con estructura en acero barnizado bronzo y detalles en latón. Elementos en forma de vela en vidrio pulegoso de Murano hechos a mano. Iluminación led abajo y arriba. Cada elemento en vidrio es único y distinto en forma y medida.

Hängelampe mit Gestell lackiert Bronze und Messingeinsätze. Kerzenelementen aus pulegoso Murano-Glas handgearbeitet. LED Beleuchtung nach unten und oben. Jedes Glaselement ist Einzigartig und unterscheidet sich in Form und Größe.

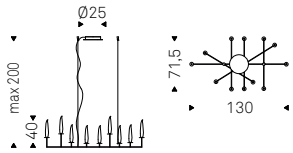





## TWISTER

### Design

#### Piervittorio Prevedello

Lampada a soffitto con struttura in acciaio verniciato gofrato titanio o cromo nero. Illuminazione a led verso il basso e l'alto.

Ceiling lamp with frame in titanium embossed lacquered or black chrome steel. Downward and upward Led lighting.

Lampadaire avec structure en acier laqué gaufré titane ou chrome noir. Éclairage à led vers le bas et vers le haut.

Lámpara de techo con estructura en acero barnizado gofrado titanio o cromo negro. Iluminación led hacia abajo y hacia arriba.

Hängelampe mit Gestell in Stahl lackiert Titan gaufriert oder schwarz Chrom. LED Beleuchtung nach unten und oben.

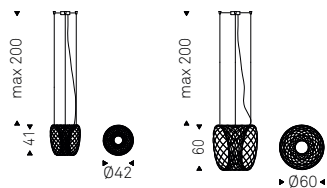









## MELODY

### Design Gregorio Facco

Lampada a soffitto con paralume in cristallo fumé. Attacco a soffitto in acciaio Nichel satinato. 1: attacco singolo. 2/6: attacco rotondo da 2 a 6 paralumi. 7/12: attacco rotondo da 7 a 12 paralumi. Lampadina inclusa.

Ceiling lamp with lampshade in fumé glass. Ceiling plate in satin Nickel steel. 1: single plate. 2/6: round ceiling plate for 2/6 lampshades. 7/12: round ceiling plate for 7/12 lampshades. Bulb included.

Lampadaire avec diffuseur en verre fumé et plafond en Nickel satiné. 1: culot single. 2/6: culot rond de 2/6 abat-jours. 7/12: culot ronde de 7/12 abat-jours. Ampoule comprise.

Lámpara de techo con pantalla en cristal fumé. Soporte de techo en acero Níquel satinado. 1: soporte único. 2/6: soporte redondo para 2/6 pantallas. 7/12: soporte redondo para 7/12 pantallas. Bombilla incluida.

Hängelampe mit Lampenschirm in Kristall fumé. Deckenbefestigung in Nickel satiniert. 1: Einzelne Anschluss. 2/6: Runde Anschluss für 2/6 Lampenschirme. 7/12: Runde Anschluss für 7/12 Lampenschirme. Leuchtmittel enthalten.

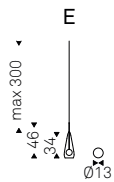
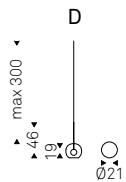
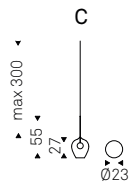
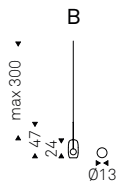
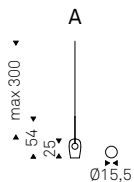

Socket 1



Socket 2 / 6



Socket 7 / 12



5

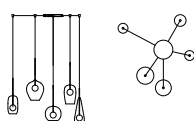

10

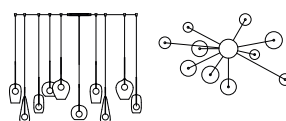







## SUNSET

Design **Oriano Favaretto**

Lampada a soffitto e abat-jour con struttura in ottone e paralume in cristallo fumé.

Ceiling lamp and table lamp with brass frame and lampshade in fumé glass.

Lampadaire et lampe de chevet avec structure en laiton et diffuseur en verre fumé.

Lámpara de techo y sobremesa con estructura en latón y pantalla en cristal fumé.

Hängelampe und Tischlampe mit Messinggestell und Lampenschirm in Kristall fumé.

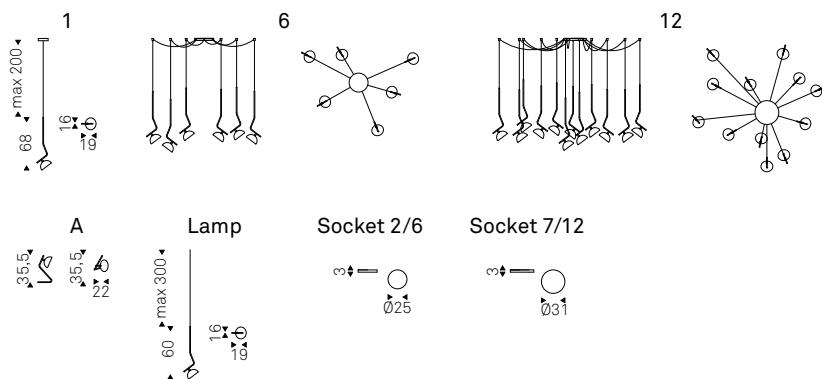







**TRAMONTO****Design Oriano Favaretto**

Lampada a soffitto con struttura in ottone e paralume in cristallo fumé.

Ceiling lamp with brass frame and lampshade in fumé glass.

Lampadaire avec structure en laiton et diffuseur en verre fumé.

Lámpara de techo con estructura en latón y pantalla en cristal fumé.

Hängelampe mit Messinggestell und Lampenschirm in Kristall fumé.

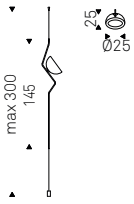

## MAMBA

Design **Piero De Longhi**

Lampada da tavolo in poliuretano rigido verniciato bianco o nero lucido o Brushed Bronze. Base in acciaio inox lucido. Illuminazione a led, lampadina inclusa.

Table lamp in polished white, black or Brushed Bronze rigid polyurethane. Base in polished stainless steel. LED light, bulb included.

Lampe de table en poliuréthane rigide laqué blanc ou noir brillant ou Brushed Bronze. Base en acier inox brillant. Ampoule led, ampoule comprise.

Lámpara de sobremesa en poliuretano rígido barnizado blanco o negro brillo o Brushed Bronze. Base en acero inox brillo. Iluminación led, bombilla incluida.

Tischlampe aus lackiertem Hartes Polyurethan glänzend weiss oder schwarz oder Brushed Bronze. Basis aus Edelstahl glänzend. LED Beleuchtung enthalten.

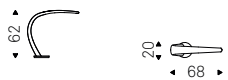



## TUCSON

### Design Emanuele Zenere

Lampada da terra con struttura in acciaio verniciato goffrato titanio, graphite o nero. Illuminazione a led.

Floor lamp in titanium, graphite or black embossed lacquered steel. Led lights.

Lampe de sol avec structure en acier gaufré titane graphite ou noir. Éclairage à led.

Lámpara de suelo con estructura en acero barnizado gofrado titanio, graphite o negro. Iluminación led.

Stehlampe mit Metallgestell lackiert titan, graphite oder schwarz gaufriert. LED Beleuchtung.

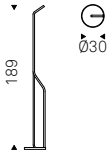



## FISHERMAN

### Design Brogliato & Traverso

Lampada orientabile da parete con struttura in acciaio verniciato gofrato titanio, bianco, nero o graphite. Illuminazione a led.

Adjustable wall lamp in titanium, white, black or graphite embossed lacquered steel frame. Led lights.

Applique murale réglable avec structure en acier gaufré titane, blanc, noir ou graphite. Éclairage à led.

Lámpara de pared ajustable con estructura en acero barnizado gofrado titanio, blanco, negro o graphite. Iluminación led.

Drehbare Wandlampe mit Metallgestell lackiert Titan, weiss, schwarz oder graphite gaufriert. LED Beleuchtung.

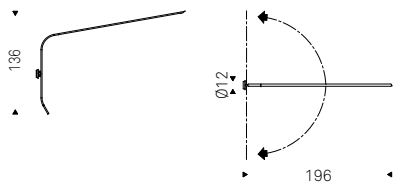



## MANHATTAN

### Design Brogliato & Traverso

Lampada da terra con struttura in acciaio verniciato gofrato titanio, graphite o nero. Lampadine non incluse.

Floor lamp in titanium, graphite or black embossed lacquered steel. Bulbs not included.

Lampe de sol avec structure en acier gaufré titane graphite ou noir. Ampoules non comprises.

Lámpara de suelo con estructura en acero barnizado gofrado titanio, graphite o negro. Bombillas no incluidas.

Stehlampe mit Metallgestell lackiert titan, graphite oder schwarz gaufriert. Leuchtmittel nicht enthalten.

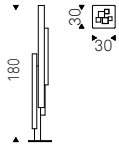





MANHATTAN lamp in titanium finish - DUMBO chair in soft leather 934 Bronzo and black frame

## SAYONARA

Design **Oriano Favaretto**

Lampada da terra con struttura in acciaio verniciato gofrato titanio e paralume in tessuto avorio o struttura in acciaio verniciato gofrato nero e paralume in tessuto nero.

Floor lamp with frame in titanium embossed laquered steel and lampshade in ivory fabric or frame in black embossed laquered steel and lampshade in black fabric.

Lampe de sol avec structure en acier gaufré titane et diffuseur en tissu ivoire ou structure en acier gaufré noir et diffuseur en tissu noir.

Lámpara de suelo con estructura en acero barnizado gofrado titanio y pantalla en tejido marfil o estructura en acero barnizado gofrado negro y pantalla en tejido negro.

Stehlampe mit Metallgestell lackiert titan gaufriert und Schirm in Elfenbeingewebe, oder Metallgestell lackiert schwarz gaufriert und Schirm in Schwarzgewebe.

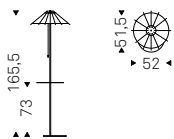



SAYONARA lamp with titanium frame and ivory lampshade - WANDA chair in soft leather 973 Nero

## NIGHTPORT

### Design Giorgio Cattelan

Cabina armadio componibile con fissaggio a muro o a soffitto. Montanti e staffe in acciaio verniciato gofrato graphite o nero. Aste porta abiti in alluminio verniciato gofrato graphite o nero. Ripiani in laminato bianco o rovere scuro. Cassettiera a 3 cassetti in laminato bianco o rovere scuro con un frontale in cristallo trasparente. Optional griglia interna per cassetteria.

Modular wall- or ceiling-hanging walk-in closet. Pillars and brackets in graphite or black embossed lacquered steel. Clothes stand in graphite or black embossed lacquered aluminium. Shelves in white or dark oak laminate. 3-drawer chest in white or dark oak laminate with 1 drawer front in clear glass. Optional drawer organizer.

Penderie modulaire avec fixation au mur ou au plafond. Montants et crochets en acier lacqué gaufré graphite ou noir. Tringles à vêtements en aluminium lacqué gaufré graphite ou noir. Étagères en laminé blanc ou laminé rouvre foncé avec un frontal en verre transparent. Optionnel: grille interne pour tiroirs.

Ropero componibile con montaje en pared o techo. Montantes y soportes en acero barnizado gofrado graphite o negro. Palos percheros en aluminio barnizado gofrado graphite o negro. Estantes en laminado blanco o laminado roble oscuro. Cajonera con 3 cajones en laminado blanco o laminado roble oscuro con un frontal en cristal transparente. Organizador interior para cajón opcional.

Begehbarer Einbauschränk mit Wand- oder Deckenbefestigung. Säule und Träger in Stahl lackiert graphite oder schwarz gaufriert. Kleiderstange in Aluminium lackiert graphite oder schwarz gaufriert. Böden in Laminat weiss oder Laminat dunkel Eiche. 3-Schubladenelement in Laminat weiss oder Laminat dunkel Eiche. Optional: Trennsteg für Schublade.

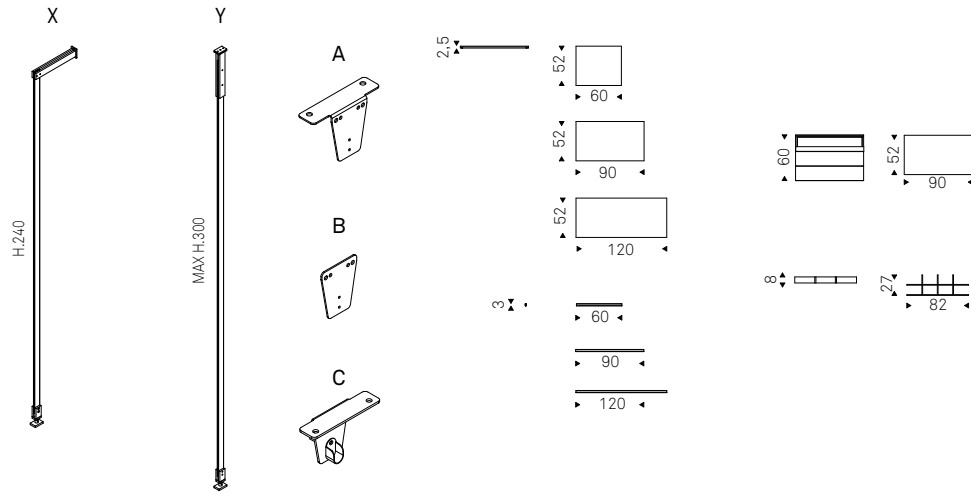







NIGHTPORT wardrobe with shelves and chests in burned oak and black frame - IMAGE mirror in fumé mirror and burned oak frame - RADJA rugs











NIGHTPORT wardrobe with shelves and chests in white finish and graphite frame - DUMBO LOUNGE chair in soft leather 973 Nero and walnut Canaletto frame  
MUMBAI rug - TAXEDO mirror in soft leather 948 Lino - SUNSET abat-jour lamp

## IMAGE

### Design

#### Gianvittorio Plazzogna

Specchio porta abiti in cristallo specchiato o specchiato fumé con struttura in frassino tinto noce Canaletto o rovere bruciato.

Clothes hanger mirror in mirrored or fumé mirrored glass. Frame in Canaletto walnut stained ashwood or burned oak stained ashwood.

Miroir portemanteau en verre miroité ou miroité fumé. Structure en frêne teinté noyer Canaletto ou frêne teinté rouvre brulé.

Espejo perchero en cristal reflejado o reflejado fumé. Estructura en fresno barnizado nogal Canaletto o fresno barnizado roble ahumado.

Kleiderständer Spiegel aus Glas verspiegelt oder Glas verspiegelt fumé. Struktur in Esche gebeizt Nussbaum Canaletto oder "verbrannte Eiche".

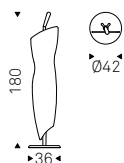





PER BARCLAY LE LIVRE NOIR  
SAVAGE MESSIAH H. S. EDE  
Kings & Pawns  
GIRLS ALoud Dreams That Glitter



MAILLÉ  
John Singer Sargent Watercolours  
Ghana A PORTRAIT  
KENNETH GUSTAVSSON  
Light! The Industrial Age 1750-1850  
Cultural Upheaval  
Art & Science, Technology & Society  
PERFUMES THE CODE  
SICA STRAIN  
SANDRINE BARRUCQUET



ADOOLF LOOS ARCHITECTURE 1903-1932 SCHNEZLER  
CONSTRUIR LA REVOLUCIO  
THE WORK OF THE KINGDOM  
WORSHIP, FEELING AND  
THE FIRST  
A SHORT HISTORY OF ENGLAND SIMON JENKINS

The Image of the Black in Western  
In fine Style The Art of Tudor

STANFILL BVLGARI

Ghana A PORTRAIT

CITIZEN  
The Image Black in Western  
DA

8

COLLECTION



cattelan  
italia

---

CATTELANITALIA.COM



**CATTELAN ITALIA** SPA - via pilastri 19 - 36010 Carrè / Vicenza - Italy  
phone +39 0445 318711 - fax +39 0445 314289 - email: info@cattelanitalia.com